

Operating Manual



Carton Force Analyser (CFA)



Thank you for purchasing this Rhopoint product.

Please read these instructions carefully before operating this product and retain them for future reference. The images shown in this manual are for illustrative purposes only.

This instruction manual contains important information about the setup and use of the Rhopoint Carton Force Analyser (CFA). It is therefore essential that the contents be read before powering up and using the instrument.

If this instrument is passed to other users you must ensure that the instruction manual is supplied with the instrument. If you have any questions or require additional information about this product, please contact the Rhopoint Authorised Distributor for your region.

The technology and components used in the device are based on state-of-the art optic and electronics. As part of Rhopoint Instruments commitment to continually improving the technologies used in their products, they reserve the right to change information included in this document without prior notice.

© Copyright 2023 Rhopoint Instruments Ltd. All Rights Reserved.

Rhopoint is a registered trademark or trademark of Rhopoint Instruments Ltd in the UK and other countries.

Other product and company names mentioned herein may be trademarks of their respective owner.

No portion of the software, documentation or other accompanying materials may be translated, modified, reproduced, copied or otherwise duplicated (with the exception of a backup copy), or distributed to a third party, without prior written authorisation from Rhopoint Instruments Ltd.

Contents

1	About the Carton Force Analyser	5
2	Accessories	6
3	Functional overview	7
4	Set-up	8
5	Power	9
6	Sample Preparation	10
8	Identifying the grain direction of carton board	10
9	Cutting samples for board stiffness measurement	10
10	Using the supplied templates	21
11	Set Test Conditions	22
13	Selecting test conditions	23
14	Test Types	23
15	Bending Resistance	23
16	Bending Moment	24
17	Bending Stiffness	25
18	Ratio of Crease to Board Stiffness	26
19	Crease Recovery Stiffness	27
20	Crease Folding Force	28
25	Crease Opening Force	29
26	Carton Opening Force	30
27	Relative Crease Strength	31
28	Geometrical Stiffness	32
29	Crease/Board Analyse	33

31	Performing a Test	34
32	Creating and editing test methods	34
33	Selecting and fitting test jaws	35
34	Running a test	36
35	View test instructions	37
36	Create test routine	37
37	Test Results	38
38	Exporting/printing results	38
39	Review previous results	39
40	Crease ratio, Interpretation of results	39
41	Calibration	41
42	Calibration check	41
43	Full calibration	42
44	Password Protection	42
45	Service and Repair	43
46	Calibration	43
47	Spares	43
48	Certificate of Conformity	44
49	RoHS and WEEE	45

 **WARNING THE HANATEK CFA HAS MOVING PARTS WHICH MAY CONSTITUTE A PINCHING RISK FOR FINGERS. REASONABLE CARE MUST BE TAKEN AT ALL TIMES – DO NOT TOUCH THE MOVING PARTS DURING OPERATION AND ENSURE HAIR AND CLOTHING IS KEPT CLEAR.**

About the Carton Force Analyser

The Hanatek Carton Force Analyser (CFA) measures the forces that limit the running speed of folding box board packaging.

By measuring the stiffness of the substrate and crease bending resistance, the user can optimise cartons for faster running and packaging speeds. The instrument allows individual creases to be analysed identifying problem areas in packaging design or manufacture.

Industry research indicates that the packaging speeds of pre-glued skillets is governed by the energy required to open creases. The Hanatek CFA is the first instrument to isolate and accurately measure this key parameter.

Accessories

The Carton Force Analyser is supplied complete with the following:

- Carton Force Analyser: All-in-one PC with software and connection cables
- Traceable calibration certificate
- Jaw Holder
- Spanner
- Sample preparation Templates
- USB Stick

Included Test Jaws:

- Carton opening force jaw
- Board stiffness jaw
- Crease stiffness jaw
- Crease opening force jaw

Optional Test Jaws:

- Rounded corner creases jaw

Functional overview



Label No.	Function
1	All-in-one PC (Software included)
2	Carton Force Analyser
3	Load cell blade
4	Test jaw bracket (motorised)

Set-up

For optimum performance use in an environmentally controlled lab.

- Unpack the unit carefully and check the contents against the packing list.
- Place the instrument on a suitable bench.
- Avoid using the instrument in areas where vibration may affect the readings; i.e. close to heavy machinery.
- Ensure the instrument is level before use.
- Place a spirit level central on the measurement platen and adjust the feet until the spirit level bubble remains central. This is important and must be periodically checked and adjusted every time the equipment is moved.
- Plug the instrument and all-in-one PC into a suitable main supply using the supplied mains leads.
- Plug the data cable (USB type B) into the back of the CFA instrument.
- Plug the other end of the cable into a USB port on back of the PC. A label will indicate the best USB port to use.

Power

⚠ CAUTION - THE HANATEK CFA IS FITTED WITH A 20N LOAD CELL. ANY FORCE ABOVE 2KG APPLIED TO THE LOAD CELL MAY RESULT IN CATASTROPHIC DAMAGE. CARE MUST BE TAKEN TO AVOID CRASHING THE LOAD CELL INTO OBSTRUCTIONS.

- Press the power up button on the PC - the instrument and PC will power up.
- Double tap on the CFA ICON on the windows screen and the software will start. Once loaded the main operating screen will be displayed. Please note the software can take up to 15 seconds to launch. DO NOT DOUBLE TAP UNLESS >15 SECONDS HAS PASSED.

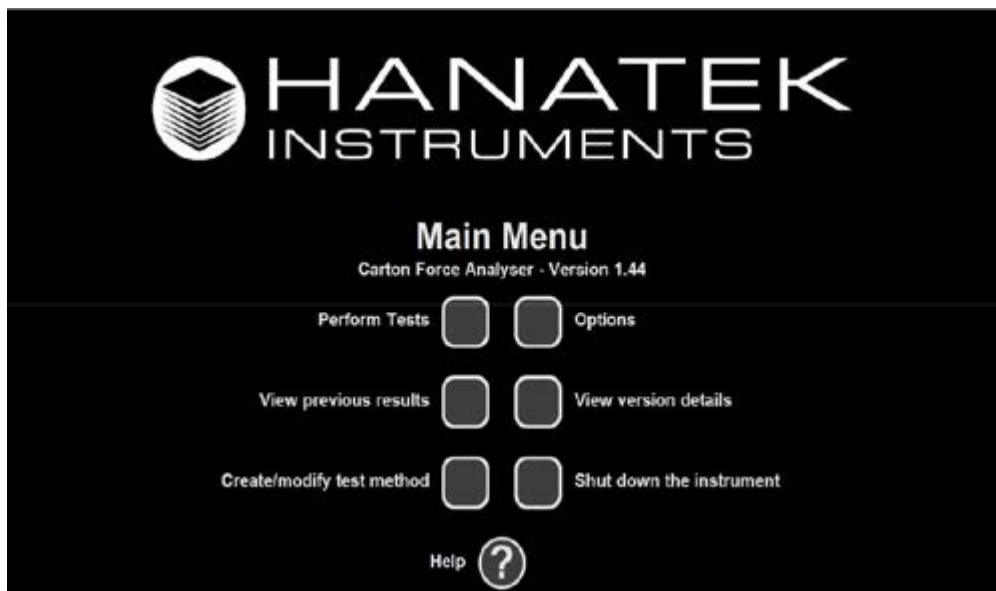

Sample Preparation

Identifying the grain direction of carton board

Board is manufactured in a continuous strip, the direction in which it moves through the board-making machine being known as the machine direction (MD). Board is always stiffer in the machine or grain direction than perpendicular to it.

This second direction is called the cross, or across grain direction (CD). The machine direction of board may be identified by flexing the board, preferably in the form of a square, holding first one pair of opposite sides, then the other. The board will feel stiffer when the machine direction runs from hand to hand. The stiffness tester is used to measure the force required to bend board in the machine and cross directions.

Cutting samples for board stiffness measurement

The required size of board sample for measuring board stiffness is 70mm x 38mm. This area should be free from creases and embossing. The board direction required for test should run along the 70 mm length of the specimen. This is illustrated in diagram 1. These samples are easily prepared using the optional dedicated sample cutter (see optional extras).

Machine direction (MD) samples are cut when the board is placed in the cutter with its MD running parallel with the cutter handle. The edge of the board must be against the stops at the hinge end of the cutter aperture.

To avoid confusion, it is helpful to label the samples MD or CD after cutting. Ten samples per direction should be tested to provide maximum accuracy and an average of the MD and CD reported.

Diagram 1

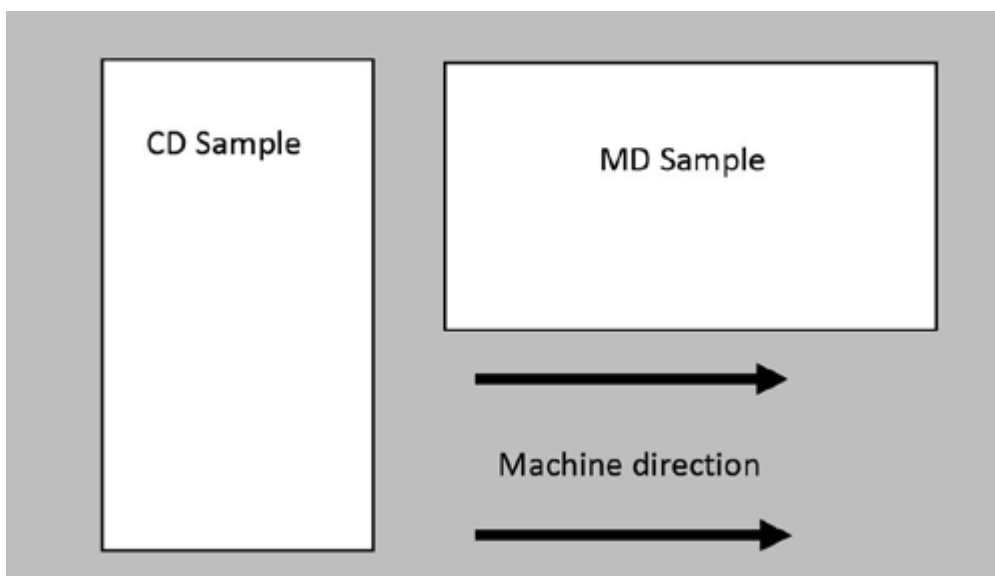

Cutting samples for crease stiffness measurement

The dedicated sample cutter can also be used for cutting the crease stiffness samples, although extra operations are required.

Diagram 2 illustrates MD and CD samples with creases across them, as will be required for crease stiffness testing.

Confusion can arise from the naming of the creases, as the crease in the MD sample runs across the grain indicated by the arrow. This crease is known as the MD crease, named after the MD sample it is taken from. Similarly, the crease in diagram 2B is known as the CD crease, it is taken from a sample cut in the CD direction. The reason for this is that the stiffness of the MD crease relates to the stiffness of the board in the MD (this is discussed in more detail later in the text).

Diagram 2

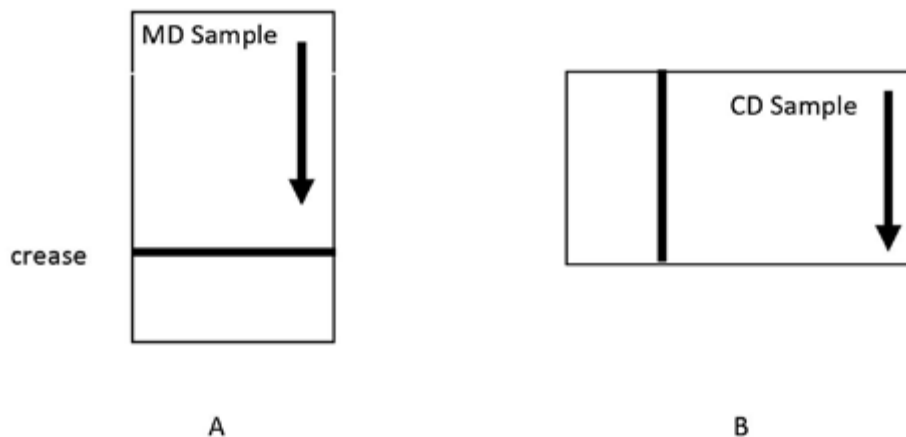

In cutting samples of creased board, it is very important that the crease is not folded or bent before the test. A sample of board is cut as for board stiffness, but with a crease running across the board, approximately central and parallel to the line of the cutter stops (see Diagram 3).

Diagram 3

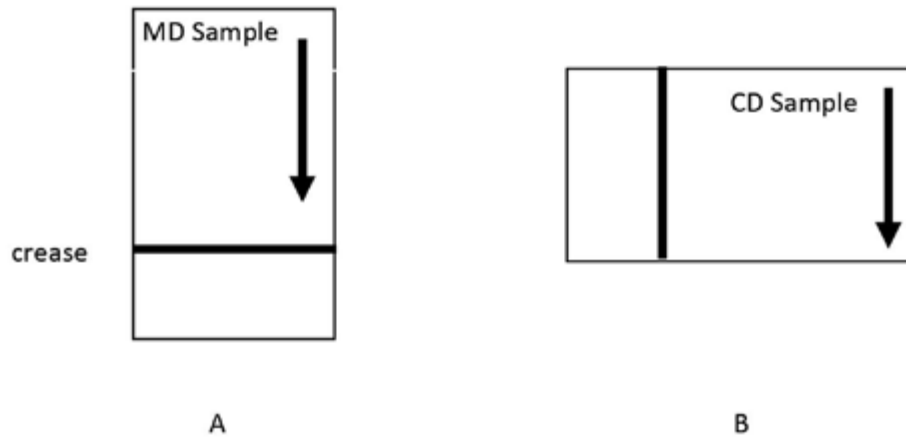

This sample requires further trimming before it is ready for testing. The sample is placed on the cutter again, positioning it using the two lines ruled on the cutter side plate.

One long edge of the sample is placed along the top ruled mark and the crease is placed along the mark parallel to the cutter edge, using the left-hand edge of the crease for alignment, as shown in diagram 4A. The right-hand end of the sample is now trimmed, taking care to keep fingers away from the cutting edges.

The sample is turned around (as in Diagram 4B, relating to the letter d in Diagram 4A) lining up the newly trimmed edge with the edge of the side plate. Trim off the other edge.

The sample is now ready for testing. Its final dimensions are 38 mm square, with 24 mm from one side to its nearest crease edge. When initially cutting the sample, it should be remembered that these final dimensions have to be achieved.

When working with cartons, identify the creases on the sample you wish to test. Take a cut and trimmed creased test piece, position this on your sample carton and decide where guillotine cuts may be necessary to enable you to extract the appropriate test pieces using the sample cutter.

Diagram 4A

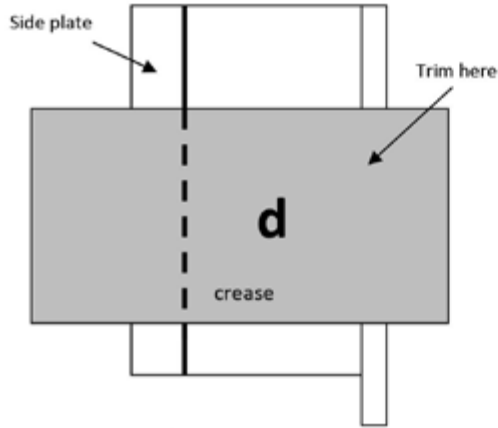

Diagram 4A

Diagram 4B

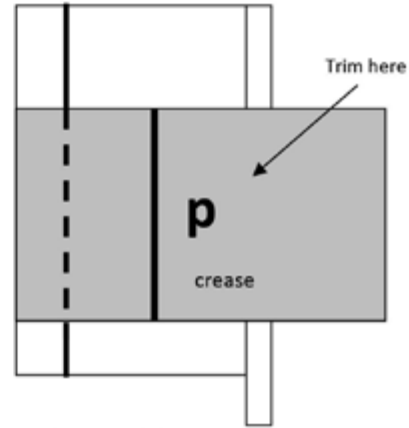
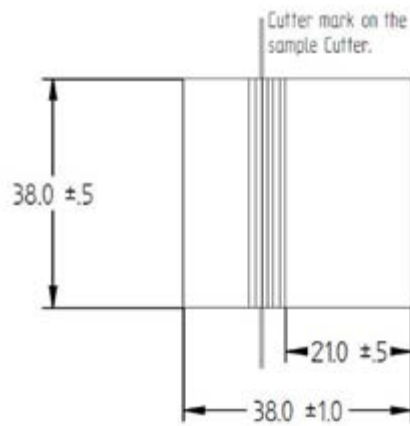

Diagram 4B

Preparing samples for rounded corner test

The samples should be cut in accordance with diagram 4C.



Preparing samples for carton opening test

The maximum recommended height for full carton force opening force jaw is 78mm tall.
If the carton to be tested is taller than this it will need to be cut down into sections.



Cut the end flaps off the carton



Divide the carton up into manageable sections



Place two lines of double-sided tape on the carton opening force jaw

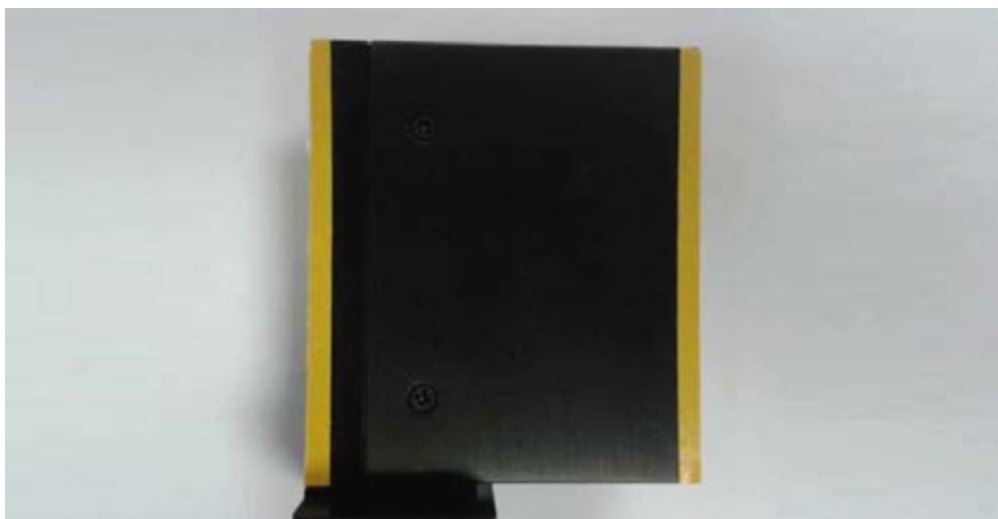

Stick the carton to be tested onto the jaw.

Line the crease to be unfolded up with the edge - for best results line the crease that does not have a glue seam.



Preparing samples for crease opening test

Carton



Cut the crease that is not required for testing



Use the sample cutter to prepare the carton. The crease to be tested is at the back

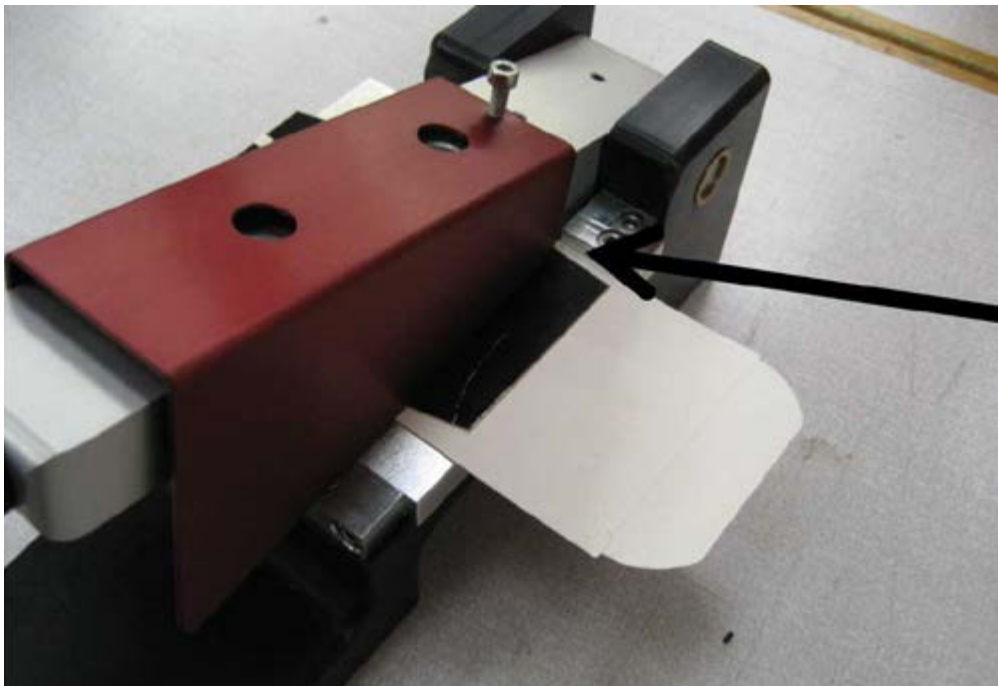

Cut sample



Place double sided tape onto crease open JAW



Stick sample onto Jaw. The crease should touch the removable alignment section of the Jaw

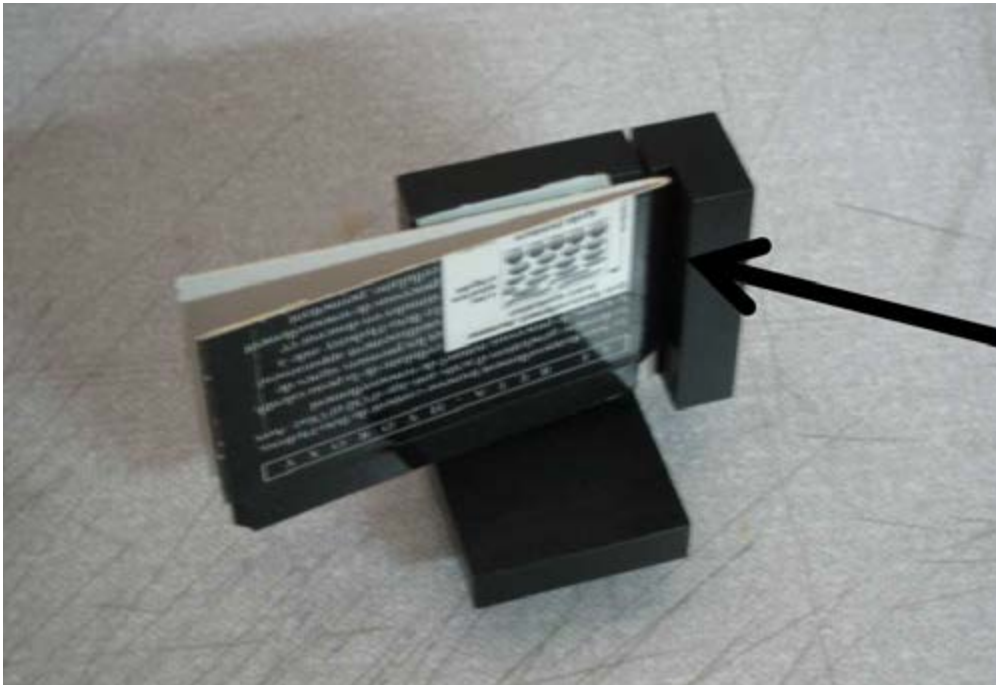

Remove the alignment section the of the Jaw



Tear off the section of the jaw closed to the jaw



Carton ready to test



Using the supplied templates

Stiffness Template: Position the template over area to be cut observing the MD and CD. Cut around the template using the knife provided.



Crease Template: Position the template with the crease line centred directly over the crease to be tested. Cut around the template using the knife provided.



Set Test Conditions

Selecting test conditions

- Various test methods are available on the Hanatek CFA instrument.
- Unused test methods can be hidden from the password protect menu.

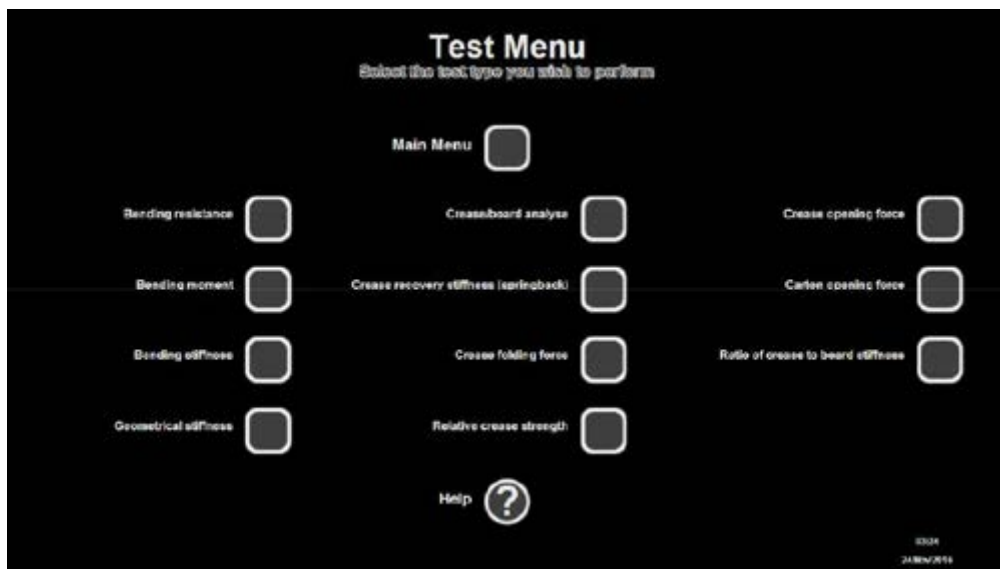

Test Types

Bending Resistance

Measures the stiffness of the board sample to ISO2493. The stiffness of the sample is measured twice, once with the printed side of the carton facing forward and the second time with the printed side facing to the rear. The resultant force is displayed in N, gF or mN. The average of the two measurements is calculated as well as the Min, Max and standard deviation on a multiple sample test.



User adjustable test parameters

Routine name:
Speed: 1-360 deg/s
Test angle: 1-45 deg
Test length: 10-65 mm
Sample width: 1-50 mm

Recommendations according to ISO2493-1

Speed: 5 deg/s
Test angle: 15 deg
(7.5 degree if the board is permanently deformed when bent at 15 degrees*)
Test length: 50 mm
Sample width: 38 mm

*IMPORTANT – The result obtained at 7.5° cannot be converted to 15° by multiplying by two, since the relationship is not directly proportional to the bending angle.

Bending Moment

Measures the stiffness of the board sample to ISO2493. The stiffness of the sample is measured twice, once with the printed side of the carton facing forward and the second time with the printed side facing to the rear. The resultant force is displayed in g/cm, Gurley units, mNm or Nm. The average of the two measurements is calculated as well as the Min, Max and standard deviation on a multiple sample test.

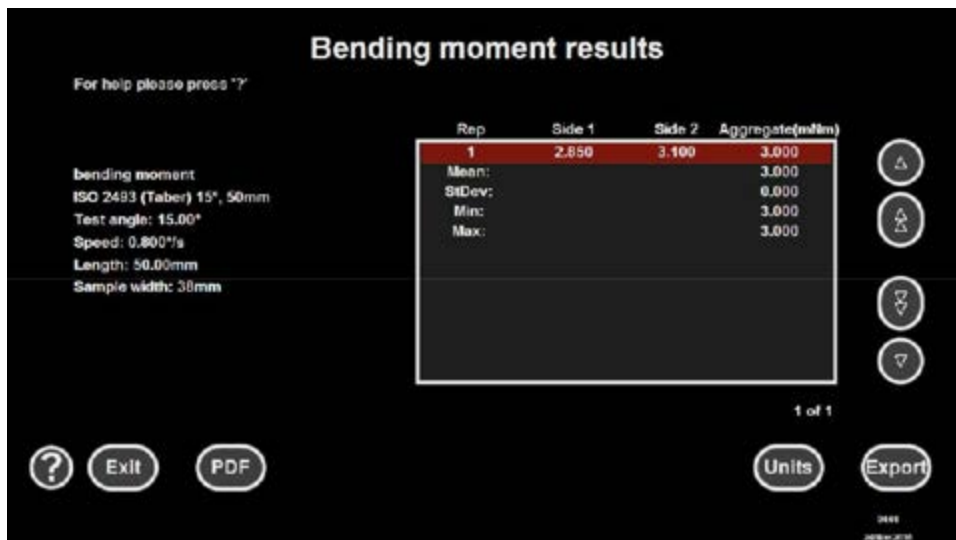

User adjustable test parameters
Routine name:
Speed: 1-360 deg/s
Test angle: 1-45 deg
Test length: 10-65 mm
Sample width: 1-50 mm

Recommendations according to ISO2493-1
Speed: 0.8 deg/s
Test angle: 15 deg
(7.5 degree if the board is permanently deformed when bent at 15 degrees*)
Test length: 50 mm
Sample width: 38 mm

***IMPORTANT** – The result obtained at 7.5° cannot be converted to 15° by multiplying by two, since the relationship is not directly proportional to the bending angle.

Bending Stiffness

The stiffness of the sample is measured with the resultant force displayed real time on the screen as the sample is rotated through the preselected test angle. At the end of the test the resultant average bending stiffness is displayed mNm and modulus of elasticity. This is calculated from the thickness of the sample that must be entered before starting the test. The thickness can be measured with the Hanatek Precision Thickness Gauge. Multiple tests can be run to compare cartons or obtain average.

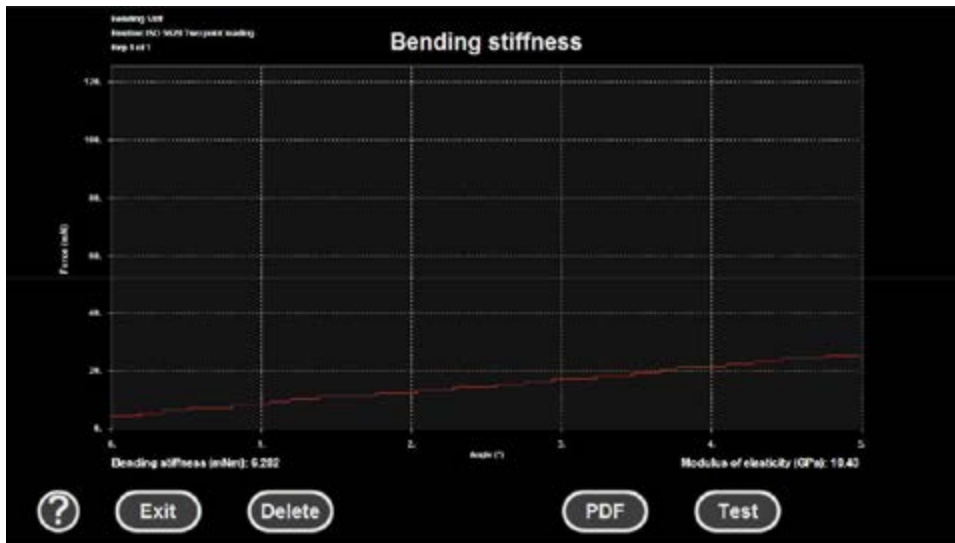

User adjustable test parameters

Routine name:

Speed: 1-30 deg/s

Test angle: 1-7.5 deg

Test length: 10-65 mm

Sample width: 1-50 mm

Ratio of Crease to Board Stiffness

The relationship between board stiffness and crease stiffness is an important factor in the running performance of cartons. This test will allow the user to quickly calculate the crease to board stiffness ratio by measuring both crease stiffness and board stiffness to the relevant standards. The Min, Max and standard deviation is also calculated on a multiple sample test.

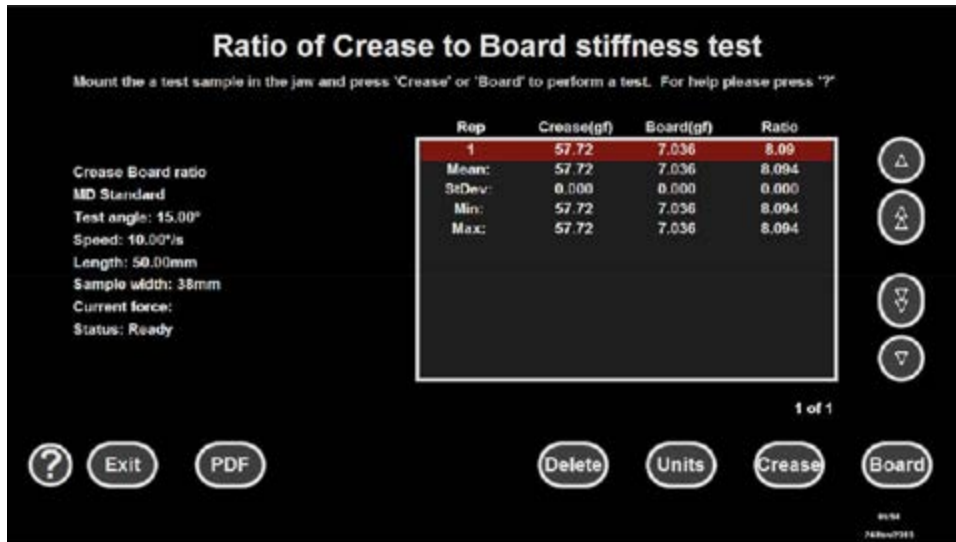

User adjustable test parameters

Routine name:

Speed: 1-360 deg/s

Test angle: 1-45 deg
(90 deg set for crease)

Test length: 10-65 mm

Sample width: 1-50 mm

Crease Recovery Stiffness

Measures the crease recovery to BS 6965. During the test, the Instrument will fold the crease under test through the preselected crease angle and hold it there for a pre-determined number of seconds. It will then measure the force exerted on the crease as the instrument rotates the sample throughout the desired test angle. The peak force is displayed as well as the angle that this force was reached. The resultant force is displayed in N, gF or mN. The average measurement is calculated as well as the Min, Max and standard deviation on a multiple sample test.



User adjustable test parameters
Routine name:
Speed: 1-360 deg/s
Test angle*: 1-155 deg
Test length: 10-65 mm
Sample width: 1-50 mm
Dwell time: 0-30 seconds

Recommendations for BS6965
Speed: 100 deg/s
Test angle: 90 deg
Test length: 10 mm
Sample width: 38 mm
Dwell time: 15 seconds

*for crease angles higher than 90deg a special jaw MUST be used.

Crease Folding Force

During the test the Instrument will fold the crease under test through the preselected crease angle. The resultant force is displayed real time on the screen as the sample is rotated through the preselected test angle. At the end of the test the resultant maximum crease stiffness is displayed in N as well as the Energy in mJ required to bend the sample. Multiple tests can be run to compare cartons or obtain average.

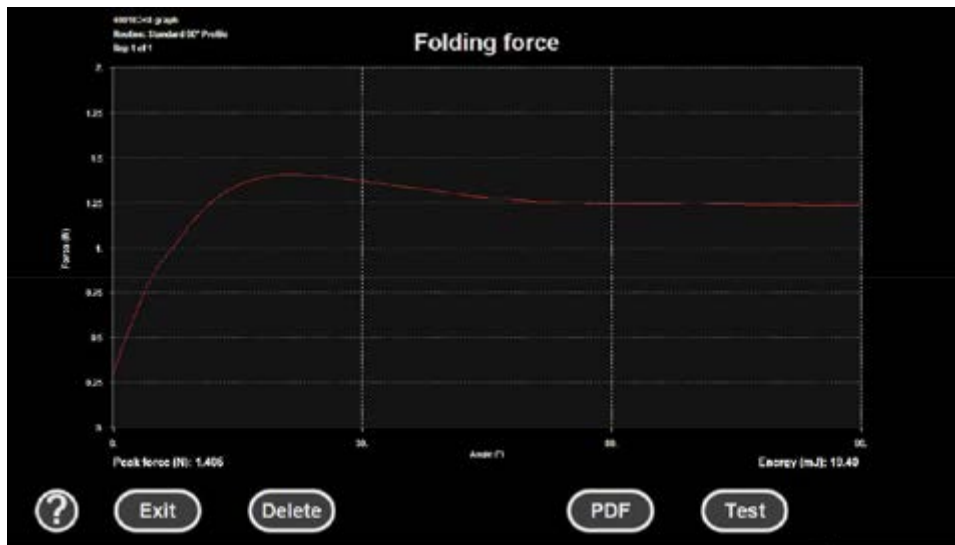

User adjustable test parameters
Routine name:
Speed: 1-360 deg/s
Test angle*: 1-155 deg
Test length: 10-65 mm
Sample width: 1-50 mm

Recommendations for BS6965
Speed: 100 deg/s
Test angle: 90 deg
Test length: 10 mm
Sample width: 38 mm
Dwell time: 15 seconds

*for crease angles higher than 90deg a special jaw MUST be used.

Crease Opening Force

During the test the Instrument will unfold the crease under test through the preselected angle. The resultant force is displayed real time on the screen as the sample is rotated through the preselected test angle. At the end of the test the resultant peak force is displayed in N as well as the energy in mJ required to bend the sample.

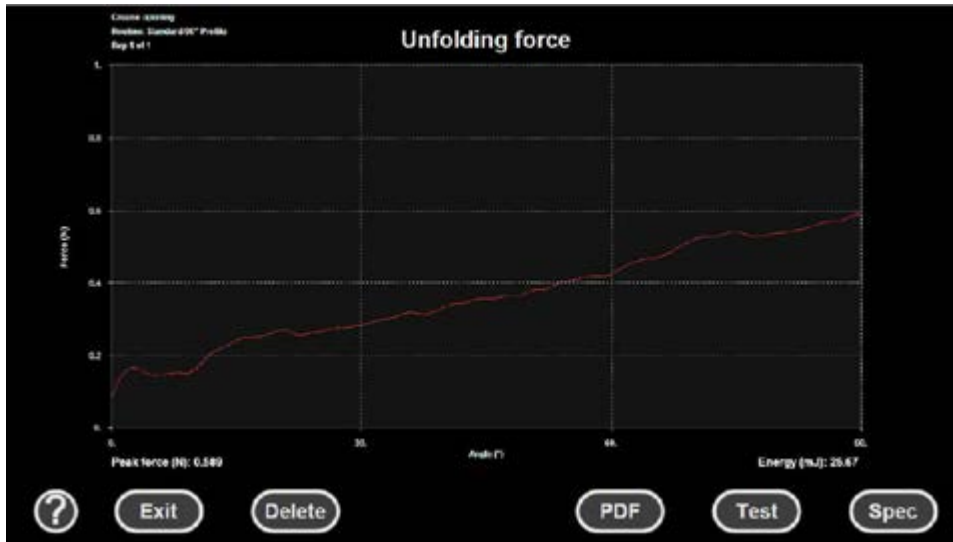

User adjustable test parameters

Routine name:

Speed: 1-360 deg/s

Test angle*: 1-135 deg

Test length: 45-65 mm

Sample width: 1-50 mm

*See sample preparation section

Carton Opening Force

This test will record the forces involved in erecting a skillet into an open carton simulating the process during machine opening. This test also allows the user to identify cartons that will not run smoothly due to a poor Ratio of Crease to Board Stiffness. The resultant force is displayed real time on the screen as the sample is rotated through the preselected test angle. At the end of the test the resultant maximum crease stiffness is displayed in N as well as the energy in mJ required to bend the sample.

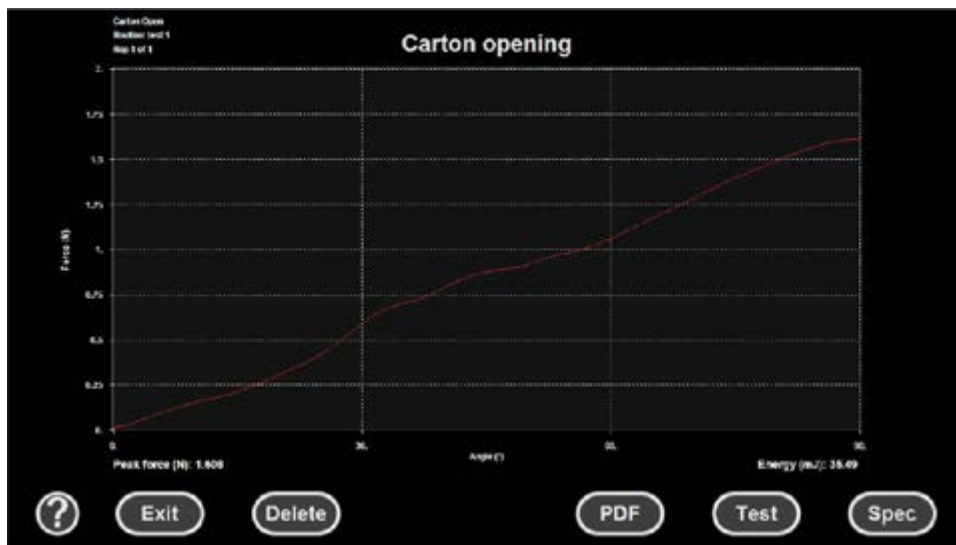

User adjustable test parameters

Routine name:
Speed: 1-360 deg/s
Test angle: 1-155 deg
Test length: 10-65 mm
Sample width: 1-50 mm

See sample preparation section

Relative Crease Strength

Measures the bending force of a creased structure and an uncreased structure and calculates the relative crease strength ratio. Results are in %. The average is calculated as well as the min, max and standard deviation on a multiple sample test.

$$\text{RCS (\%)} = \frac{\text{Bending force of the crease (mN)}}{\text{Bending force of the uncreased board (mN)}} * 100$$

Both maximum force RCS and the RCS at the maximum angle is reported.

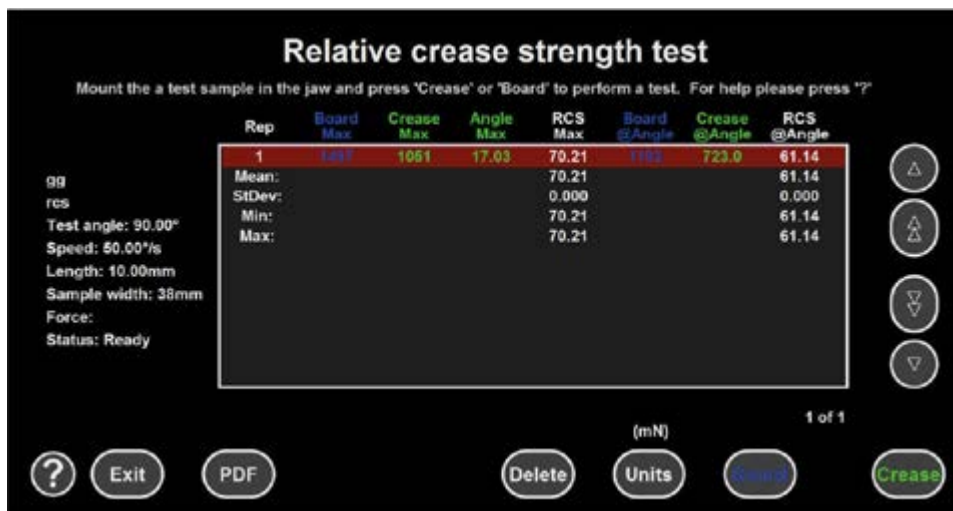

User adjustable test parameters

Routine name:
Speed: 1-360 deg/s
Test angle: 1-90 deg
Test length: 10-65 mm
Sample width: 1-50 mm

Geometrical Stiffness

Measures the bending stiffness of the structure in both MD and CD and calculates the geometrical stiffness. Results are in mN. The average is calculated as well as the min, max and standard deviation on a multiple sample test.

$$\text{Geometrical stiffness (mN)} = \sqrt{\text{Bending stiffness MD} * \text{Bending stiffness CD}}$$

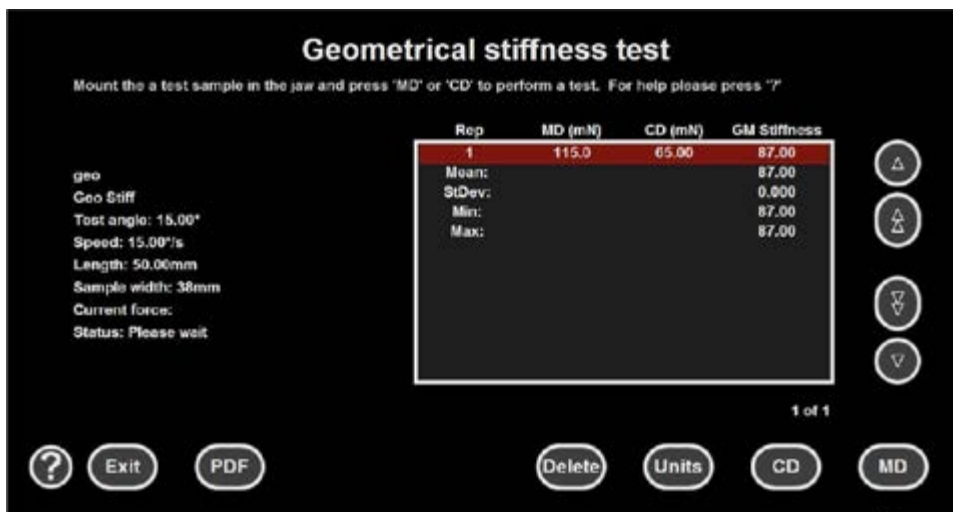

User adjustable test parameters

Routine name:

Speed: 1-360 deg/s

Test angle: 1-100 deg

Test length: 10-65 mm

Sample width: 1-50 mm

Crease/Board Analyse

Displays the graph of the force vs. angle needed to bend a sample to a certain angle, at a certain speed, with a certain relaxation time. Calculates as well the maximal force (Fmax) in mN, the maximal angle Φ_{max} in degree, the moment at relaxation M relax in mNm, the total work at stop W stop in mJ, the angle after relaxation Φ_0 in degree and the stiffness in Nm. The average is calculated as well as the min, max and standard deviation on a multiple sample test.

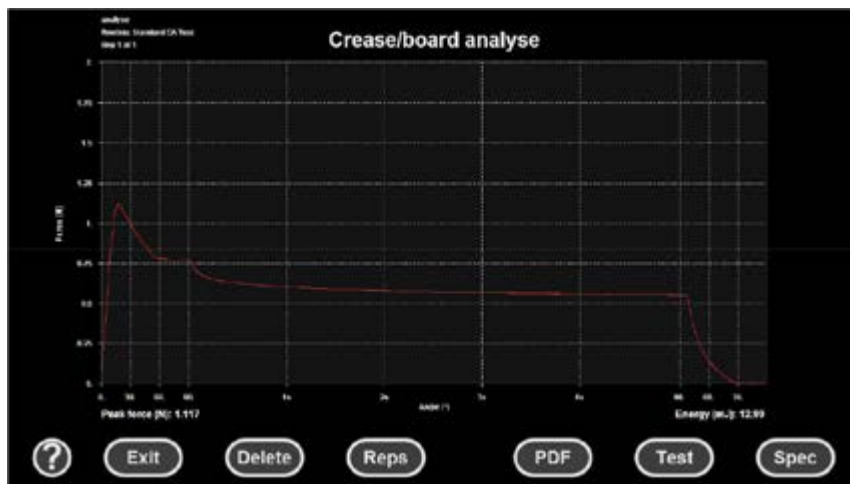

Standard CA Test: analyse

Rep	F Max (mN)	Φ Max (°)	M relax (mNm)	Wstop (mJ)	Φ_0 (°)	Stiff (Nm)
1	1117	17.10	5.490	12.99	33.70	0.004
Mean:	1117	17.10	5.490	12.99	33.70	0.004
StDev:	0.000	0.000	0.000	0.000	0.000	0.000
Min:	1117	17.10	5.490	12.99	33.70	0.004
Max:	1117	17.10	5.490	12.99	33.70	0.004

1 of 1

Graph

User adjustable test parameters

Routine name:
Speed: 1-360 deg/s
Test angle: 1-100 deg
Test length: 10-65 mm
Sample width: 1-50 mm
Dwell time: 0-30 seconds

Pressing **Reps** will bring up the test data figures. Return to the test page and graph by pressing **Graph**.

Performing a Test

Creating and editing test methods

⚠ CARTON FORCE ANALYSER TEST METHODS CONTAIN INFORMATION ABOUT TEST SET UP ONLY - DWELL TIMES, SPEED, DISTANCE ETC. FOR DETAILS ON RUNNING TESTS WITHING THE LISTED STANDARD IT IS ALWAYS ADVISABLE TO PURCHASE A COPY OF THE STANDARD. THE FULL STANDRDS CONTAIN DETAILS ABOUT SAMPLE PREPERATION, CONDITIONING AND TESTING THAT IT IS NOT POSSIBLE TO LIST WITHIN THE CFA SOFTWARE. TESTING STANDARDS ARE UPDATED AND REVIEWED CONSTANTLY; IT IS THE USERS RESPONSIBILTY TO ENSURE TEST METHODS ARE UP TO DATE, ACCURATE AND RELEVANT TO THEIR INDUSTRY.

Before a test can be performed, a test routine needs to be created. Several default test routines are pre-programmed onto the CFA instrument prior to dispatch. To review the pre-programmed routines and create new ones press the create modify test routine button from the main menu.

Select the test type required to review the programmed test routines. The pre-programmed routines can be scrolled through using the arrows to the side of the screen. A summary of the test parameters can be seen at the bottom of the screen. Press EDIT or NEW to create or edit a routine, the below routine editor screen will be displayed.



Routine name:	The name of the test routine, for example the carton ID.
Speed:	The speed of rotation.
Test angle:	The angle that the jaw will rotate.
Test length:	The distance from the point of rotation to the measuring blade.
Sample width:	The width of the sample under test
Dwell time (crease test only):	The time the sample will be held at the maximum angle before returning
Specification	Pass and fail criteria if known.

The parameters required for the test can normally be found in the standard of compliance. Once a routine has been created it can be selected from the perform test menu.

Selecting and fitting test jaws

The Hanatek Carton Force Analyser is supplied with four* magnetically fixed sample jaws which are precisely engineered to comply with relevant test standards. The instrument displays a picture on screen of the jaw required for each test.

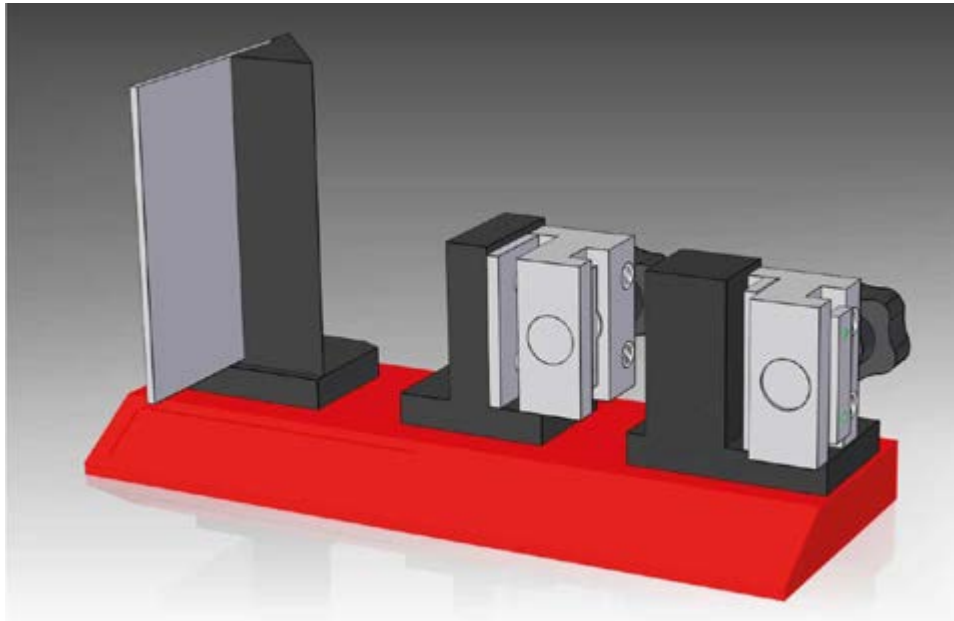

- To change a jaw, grip firmly and lift off.
- The replacement jaw should be taken from the holder.
- Place into position on the instrument using the two guide dowels. The magnets will firmly hold the jaw in place.

*Additional jaws are available.

Running a test

- Go to MAIN MENU > PERFORM TEST

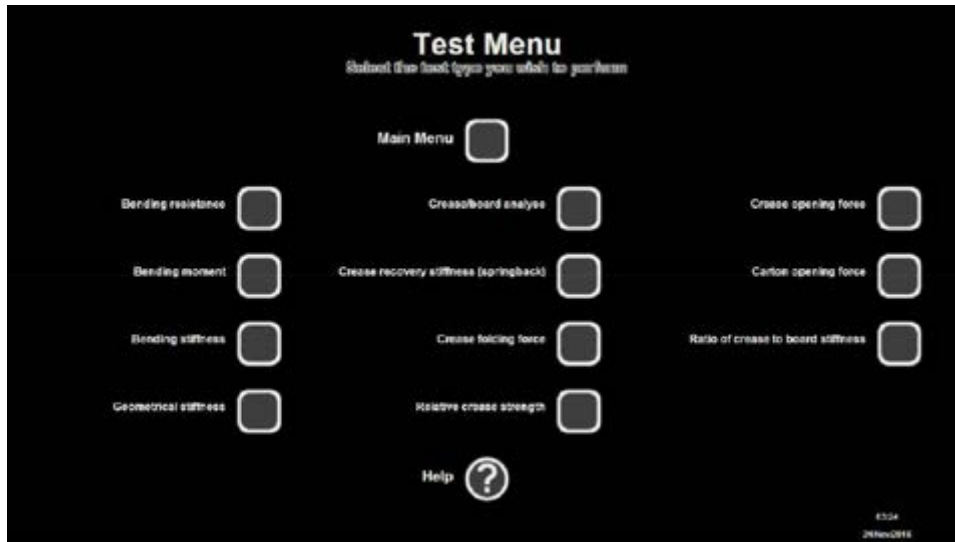

- Select the test type required and then from the list of routines select the desired routine.
- Note at the bottom of the screen is a test parameter summary.
- Observe the on-screen safety precautions and fit the relevant test jaw for the test being performed.
- There will be an image of the jaw displayed.
- Enter the name of the test about to be performed. It is recommended that the user give the test a name that can be easily identified for later use if the test routine is saved; e.g. job number. *This is the only field that is required, further notes can be added in the operator field if required. This will be added to the test report.*



- The next displayed screen will depend on the test type being performed (see test types).
- Follow onscreen prompts to conduct the test.
- Pressing **SAVE** at the end of a test will save the data and create an export .txt file. This will be saved in a folder on the C: drive called 'CFA export'.

View test instructions

- Go to MAIN MENU > OPTIONS > TEST INSTRUCTIONS

Press the **HELP** button for graphical instructions

Create test routine

- Go to MAIN MENU > CREATE/MODIFY TEST METHOD

Press the **HELP** button for graphical instructions.

- Select the relevant test method and create/modify as required referring to the corresponding test types section of this document.

Test Results

Exporting/printing results

- Go to MAIN MENU > VIEW PREVIOUS TEST RESULTS
- Select the test type for results you want to view.
- Use the **UP** and **DOWN** arrows to select the test required. Note the results can be sorted by name or test date.
- It is also possible to search for a test by pressing the **SEARCH** button.
- Select the test name and press **DETAILS**.
- To **PRINT** results to PDF, press the **PRINT** button.
- To **EXPORT** results, plug in the supplied USB data drive into any free USB port. Press the **EXPORT** button. The results will be output as a .txt file that can be viewed in any commercial spread sheet software.
- All tests that have been saved will automatically also be saved as a .txt version that can be opened in many data processing packages.
- The files will be save on the "C:" disk called in a file "CFA Export". Inside this file you will have a folder for each test type then inside the exported file. The export function in the review previous tests screen will still work in the same way and will export to the highest drive letter.

CFA	28/03/2017 10:42	File folder
CFA Export	24/03/2017 08:20	File folder
CFA Test data	07/02/2017 11:24	File folder
CFA Test data1	15/03/2017 14:26	File folder

Carton Opening	24/03/2017 12:51	File folder
Crease	24/03/2017 12:42	File folder
Crease Analyse	24/03/2017 12:00	File folder
Folding	24/03/2017 12:47	File folder
Geometrical Stiffness	24/03/2017 11:55	File folder
Moment	24/03/2017 11:11	File folder
Ratio	27/03/2017 08:33	File folder
Relative Crease Strength	24/03/2017 12:50	File folder
Resistance	24/03/2017 10:11	File folder

Review previous results

When a test is saved it can be reviewed later.

The results from the following tests can compared to previous tests.

- Bending stiffness
- Crease folding force
- Crease opening force
- Carton opening force

Under normal testing conditions if the testing involved a graphical force curve, two tests can be overlaid and compared to previous tests.



Crease ratio, Interpretation of results

The quality of a crease for machine packing can initially be assessed by its appearance. Cracking of the liner or back of the board are obvious defects. An irregular crumpled appearance of the rib on the inside of the fold can also indicate a potentially unsatisfactory crease in carton erection and closure.

Even without these visual defects, creases can be too stiff for successful carton performance on the packing line. Studies by Pira and other Institutes have shown that the critical factor is the ratio of crease stiffness to board stiffness, both measurements being made in the same grain direction of the board.

BS6965 studies have shown that successful carton performance can be anticipated if this ratio of crease/board stiffness is in this range when measurements in g.cm and g are taken directly from the display.

MD 1.5 to 3

CD 3 to 7

Packaging machine trials will enable suitable ranges for this ratio to be determined in other situations.

It should be noted that these limits are general guide-lines and may need revision against any specific application.

Both board and crease stiffness will change with variations in moisture content. Standard tests are conducted at 23°C.

50% rh. Board in equilibrium with high humidity must be expected to give lower readings.

Should it be necessary to reduce crease stiffness for a particular board, then an optimum crease width should be selected which avoids visual defects in the folds. At this groove width, deeper impressions will reduce crease stiffness.

Board stiffness can be measured using the instrument according to ISO 2493 and BS3748.

The procedure and test conditions closely resemble those required by, TAPPI T489 and parts of DIN 53121 and SCAN P29 though some differences in detail occur. Good comparability of results can be expected with other instruments satisfying these standards.

Some instruments provide board stiffness in g.cm or mN.m - units of bending moment. These can readily be converted to mN, or vice versa. The Taber type of instrument has a bending length slightly higher than 50mm and this gives a corresponding change in correction factor.

Thus the strict conversion of gramme force centimetres to milli- Newtons is:

$$\text{mN} = \text{g.cm} \times 1.96$$

The conversion for a Taber 150-B instrument is: $\text{mN} = \text{g.cm} \times 2.03$

A derivation of the analyses for this can be found in ISO 2493

15 second crease stiffness (described sometimes as crease recovery or spring back force) can be measured according to BS6965 part 1.

The 15 second spring back force will be of relevance to the carton shape (excessive crease stiffness can cause panel bowing) and to the rupture force on developing adhesive bonds.

The "dynamic" crease stiffness (the peak force during folding) will be of relevance to behaviour on carton erection mechanisms for flap folding.

Carton opening force will be of relevance to behaviour on carton erection machinery for in-feed erection (other than machines which erect cartons by diagonal loading).

It is often the case that some correlation will exist between dynamic and 15s crease stiffness, and so 15s crease stiffness will give an indication of machine behaviour. However correlation is not certain and so the use of both dynamic and 15s data is preferable.

Machine direction creases are often pre-folded during seam glueing. Some carton erection/filling machines reverse fold dust flap creases. Such situations will, for example, favour a carton opening force test against one for MD crease stiffness and may demand revision of the limits given above for cross direction crease analysis.

Calibration

Calibration check

If required, it is possible to check the instrument calibration. To check the absolute values obtained by the instrument a quadrant balance and weights should be used to apply forces directly to the loadcell.



- Go to MAIN MENU > OPTIONS > CALIBRATION CHECK
- Pressing the check button will give a live force reading from the load cell. The force reading will be displayed to the right of the check box.
- Pressing the 10mm or 50mm buttons will move the load cell blade to the corresponding position. Note, this dimension is from the point of rotation and not always the clamping edge of the jaw.
- Pressing the 15 deg and 90 deg will move the jaw to the corresponding position.

*If the results are outside these tolerances the instrument requires recalibration - contact Hanatek instruments for your local service centre

Full calibration

 **WARNING - CALIBRATION SHOULD ONLY BE ATTEMPTED BY AUTHORISED CALIBRATION PERSONNEL. FAILURE TO ADHERE TO A PRESET CALIBRATION ROUTINE WILL RESULT IN ERRONEOUS READINGS AND POSSIBLE DAMAGE TO THE INSTRUMENT. CONTACT HANATEK FOR MORE DETAILS.**

The instrument has a four-point calibration that is used to linearise the loadcell. The loadcell should be calibrated on an annual basis.

Password Protection

To prevent the operator altering or deleting test methods and/or results password protection can be enabled on the instrument.

- Go to MAIN MENU > OPTIONS > PASSWORD PROTECTION. Press the **HELP** button for graphical instructions.
- The instrument will prompt for a password - the factory default password is "Hanatek" (note: capital H).
- Type this password in using the on-screen keyboard. The instrument will now allow the user to change and activate password protection.

Service and Repair

Calibration

- To maintain the optimum performance of this machine Hanatek Instruments recommends an annual recalibration of the equipment.
- A full list of service centres can be found on the Hanatek website:
www.hanatekinstruments.com/support/authorised-service-centres

Spares

Product	Order Code
Crease Jaw	HAN-H-CREASEJAW
Stiffness Jaw	HAN-H-STIFF/J
Crease Opening Force Jaw	HAN-B10010-CREASEOPEN
Carton Opening Force Jaw	HAN-H-OPENFORCE
Rounded Corner Jaw	HAN-A-CFARNDJAW
RCS / TAPPI T577 Jaw	HAN-A-TAPPIT577/RCS
Power pack	HAN-H-PSUCFA

For any service or repair queries contact HANATEK instruments:

Tel: +44 (0)1424 739623

Email: support@hanatekinstruments.com

Website: www.hanatekinstruments.com

CE Certificate of Conformity



Certificate of Conformity

This is to certify that device known as

*Rhopoint-Hanatek
Carton Force Analyser - CFA*

has been tested and found to satisfy and comply with the
CE Marking requirements of the relevant parts and portions
of the specifications listed below.

Tested By:



Marc Dekenah (on behalf of Rhopoint Instruments)

04 August 2011

Date:

Accepted and Logged By:



Tony Burrows (Managing Director, Rhopoint Instruments)

04 August 2011

Date:

BS EN 61010-1:2010 Clause 6
BS EN 61000-4-2:2009
BS EN 61000-6-3:2007
BS EN 61000-6-1:2007



hanatek

RoHS and WEEE

EU Directive 2002/96/EC on WEEE (Waste Electrical & Electronic Equipment) and RoHS (Restriction of the use of certain Hazardous Substances).

The European Union's Directive on Restriction of the use of certain Hazardous Substances in electrical and electronic equipment (ROHS) defines each of 10 categories of electrical and electronic equipment in Annex I. Category 9 is defined as follows:

9. Monitoring and control instruments

Smoke detector

Heating regulators

Thermostats

Measuring, weighing, or adjusting appliances for household or as laboratory equipment

Other monitoring and control instruments used in industrial installations (e.g. in control panels).

The RoHS Directive defines the scope of restrictions in Article 2 as follows:

"1. Without prejudice to Article 6, this Directive shall apply to electrical and electronic equipment falling under the categories 1, 2, 3, 4, 5, 6, 7 and 10 set out in Annex IA to Directive No 2002/96/EC (WEEE) and to electric light bulbs, and luminaires in households."

This product is supplied as a Monitoring and Control instrument and as such falls within category 9 of the EU directive 2002/96/EC and so is excluded from restrictions under the scope of the RoHS Directive.

The Waste Electrical and Electronic Equipment Directive is intended to reduce the amount of harmful substances that are added to the environment by the inappropriate disposal of these products through municipal waste.

Some of the materials contained in electrical and electronic products can damage the environment and are potentially hazardous to human health; for this reason, the products are marked with the crossed-out wheellie bin symbol which indicates that they must not be disposed of via unsorted municipal waste.

Rhpoint Instruments Ltd have arranged a means for our customers to have products that have reached the end of their useful life safely recycled. We encourage all end users to contact us at the end of the product's life to return their purchase to us for recycling as per Article 9 of the WEEE Directive.

Please contact us on +44 (0) 1424-739622 and we will advise on the process for returning these waste products so we can all contribute to the safe recycling of these materials.

Rhopoint Instruments Ltd

Rhopoint House, Enviro 21 Park,
Queensway Avenue South,
St Leonards on Sea, TN38 9AG, UK

T: +44 (0)1424 739 622

E: sales@rhpointinstruments.com

www.rhpointinstruments.com

Rhopoint Americas Inc.

1000 John R Road,
Suite 209, Troy,
MI 48083, USA

T: 1.248.850.7171

E: sales@rhpointamericas.com

www.rhpointamericas.com

Rhopoint Instruments GmbH

Seebauer Office Center,
Am Weigfeld 28,
83629 Weyarn, Deutschland

T: +49 8020 9214-988

E: info@rhpointinstruments.de

www.rhpointinstruments.de