



## Operating Instructions

Thank you for purchasing this Rhopoint product.  
Please read these instructions carefully before operating this product and retain them for future reference.

English

This instruction manual contains important information about the setup and use of your Rhopoint TAMS™. It is essential that the contents be read before powering up and operating the instrument.

If this instrument is passed to other users, you must ensure that the instruction manual is supplied with the instrument. If you have any questions or require additional information about the Rhopoint TAMS™ please contact the Rhopoint Authorised Distributor for your region.

The technology and components used in the device are based on state-of-the art optic and electronics. As part of Rhopoint Instruments commitment to continually improving the technologies used in their products, they reserve the right to change information included in this document without prior notice.

© Copyright 2017 Rhopoint Instruments Ltd. All Rights Reserved.

Rhopoint TAMS™ and Rhopoint™ are registered trademarks of Rhopoint Instruments Ltd. in the UK and other countries.

Other product and company names mentioned herein may be trademarks of their respective owner.

No portion of the software, documentation or other accompanying materials may be translated, modified, reproduced, copied or otherwise duplicated (with the exception of a backup copy), or distributed to a third party, without prior written authorization from Rhopoint Instruments Ltd.

Rhopoint Instruments Ltd.  
Enviro 21 Business Park  
Queensway Avenue South  
St Leonards on Sea  
TN38 9AG UK  
Tel: +44 (0)1424 739622  
Fax: +44 (0)1424 730600

Email : [sales@rhopointinstruments.com](mailto:sales@rhopointinstruments.com)  
Web site : [www.rhopointinstruments.com](http://www.rhopointinstruments.com)

Revision – 29/03/2022

# Contents

<b>Storage and Handling</b>	<b>4</b>
<b>Instrument cleaning</b>	<b>5</b>
<b>TAMS measuring Clear-Coat</b>	<b>6</b>
<b>TAMS measuring E-Coat and R-Mat (raw material)</b>	<b>8</b>
<b>TAMS O-Rough algorithm (E-Coat and R-Mat)</b>	<b>10</b>
<b>Accessories</b>	<b>11</b>
<b>Functional overview</b>	<b>12</b>
<b>Power</b>	<b>13</b>
<b>Main Screen</b>	<b>17</b>
<b>Information Screen</b>	<b>19</b>
<b>Menu Screen – Organisation and navigation</b>	<b>21</b>
<b>Menu Screen – OPERATOR functionality description</b>	<b>23</b>
<b>Menu Screen – ADMIN functionality description</b>	<b>26</b>
<b>Calibration and Verification</b>	<b>32</b>
<b>Basic Measurement</b>	<b>34</b>
<b>Measurement using My car feature</b>	<b>36</b>
<b>How to setup My Car</b>	<b>39</b>
<b>Results indices and memory organisation</b>	<b>41</b>
<b>Long press command reminder</b>	<b>43</b>
<b>Transfer results on SD card</b>	<b>44</b>
<b>How to read *.res file format on PC</b>	<b>49</b>
<b>Troubleshooting</b>	<b>50</b>
<b>TAMS Licence keys</b>	<b>53</b>
<b>Technical Specification</b>	<b>54</b>

## Storage and Handling

- This instrument contains precision optics and electronics. You should avoid knocking or dropping the device as the resulting impact could cause serious damage.
- In some circumstances the optical components in the instrument could become misted because of temperature change. It is recommended that the instrument is not used until it has stabilised to ambient temperature.
- Ensure that the instrument is not exposed to moisture, chemicals or to any corrosive vapours.
- Do not interfere or place any objects inside the measuring aperture as damage to the measuring system could occur.
- The instrument housing and screen are normally resistant to a variety of solvents however it is not possible to guarantee resistance to all chemicals; therefore, the surfaces of the instrument should only be cleaned using a soft, moist cloth.
- Prevent exposure of the instrument to direct sunlight for prolonged periods and to continuous humidity and condensation.

## Instrument cleaning

It is recommended to regularly check that both the internal screen and the lens of the camera are clean. Too much dust inside could affect readings and measurement results. It is recommended to always fix the rubber aperture cap when the instrument is not used.

Nevertheless, if dust is noticed inside the instrument, it is highly recommended to gently use clean air pressured to clean the inside of the unit.

In case dust dot would not go off, the user can also use a cotton swab with a little bit of alcoholic solution.

### **My TAMS says “Factory Service and Calibration is needed!”**

Your TAMS needs to have service and calibration in factory. Please contact your distributor to return your TAMS for annual checking. This message will pop-up automatically after 100,000 measurement or after one-year usage.

## TAMS measuring Clear-Coat

The Rhopoint TAMS has been designed to give inspectors at the production line an audit tool which predicts how a customer will judge an automotive body finish in a showroom – will it yield a good or bad impression? Two new metrics are used to define the overall visual surface appearance, Quality and Harmony, replacing traditional multi-dimensional scaling's that have caused confusion amongst automotive manufacturers in the interpretation of results for many years. Those two metrics have been designed in collaboration with Volkswagen to satisfy their requirement. In the TAMS algorithm menu selection, user should select “CC-TAMS-STD” for the surface type “C-Coat” to use this original measurement method.

**Remark:** TAMS has got capability for others analysis method for C-Coat. Rhopoint can provide **custom computation algorithm for special application**. User should contact distributor for more information.

The new metrics predict the visual appearance of a reflective surface, essentially a top coated surface (Clear-Coat):

### Quality (Q) & Harmony (H)

- **Quality** represents the overall appearance of a surface finish. It is calculated using a specific algorithm combining three sub-characteristics: Contrast, Sharpness and Waviness. The Quality value goes from 0% (Poor quality) to 100% (Mirror finish quality).
- **Harmony** quantifies the surface texture difference between two painted surfaces when placed side by side. Do they have similar orange peel aspect or not? This value is calculated using two sub-characteristics: Waviness and Dimension. A result below 1 indicates that more than 50% of people would visually accept the surface structure difference in appearance between two surfaces. A value above 1 indicates that less than 50% would accept it.

To calculate Quality and Harmony, four sub-characteristics are firstly calculated by the instrument:

Contrast (C), Sharpness (S), Sharpness-Q (Sq), Waviness (W), Dimension (D)

- **Contrast** represents the difference between the reflection intensity of highlights (bright light sources) and lowlights (dark areas) of a reflected image on a surface. A value close to 100% (black reflective surfaces and mirrors) indicates that the reflected image is showing both very high and very dark light, in other words, the range from dark light to high light is large. On the contrary, low contrast values (<30%) indicate that the range is small, so dark and high light are in a short intensity range.
- **Sharpness** represents the level of detail in the reflected image for a close look (<30cm) and the haze effect for a larger viewing distance (>1.5m). The value goes from 0% (low sharpness) to 100% (high sharpness).
- **Sharpness-Q** This is a rescaled version of the classic Sharpness parameter. Weighting has been improved especially for Quality calculation, and Contrast value is considered. Scale is still from 0 to 100%. This metric is not displayed into the screen but is accessible after data export.

- **Waviness** represents the overall wavy or non-flat aspect of the surface, also seen as a deformation level of the reflected image. The value goes from 0 (surface perfectly flat, reflection without local distortion) up to 30 (very wavy surface, high distortion level).
- **Dimension** represents the main structure size perceived at 1.5m. The value is given in millimetres ranging from 0.5 to 8mm.

## TAMS measuring E-Coat and R-Mat (raw material)

As detailed before, Rhopoint TAMS has been designed to investigate the quality of reflective surfaces such as Clear-Coat. However, for paint applications the final surface quality depends on surface roughness at different stages of the process. Therefore, measuring of during those different stage – Raw material stage or E-Coated stage - provides extremely useful data.

TAMS is capable in investigating Electro-Coat and Raw-Materials with its standard algorithm called EC-RM-TAMS-STD that user can choose in the Menu algorithm area for the surface type E-Coat or R-Mat. See further in this documentation. EC-RM-TAMS-STD is one algorithm, that can be chosen when measuring E-Coat, or R-Mat, or both. This is independent to the surface type but cannot be used for C-Coat.

***Remark:*** TAMS has got capability for others analysis method for E-Coat and R-Mat. Rhopoint can provide **custom computation algorithm for special application**. User should contact distributor for more information.

This standard algorithm provides several parameters called Optical-Ra, Optical-Rq, Waviness, and Quality. The full-field altitude map is computed and used for calculating those parameters. Several linear xz cross sections are extracted from the topography and used for the calculation. No filtering is applied.

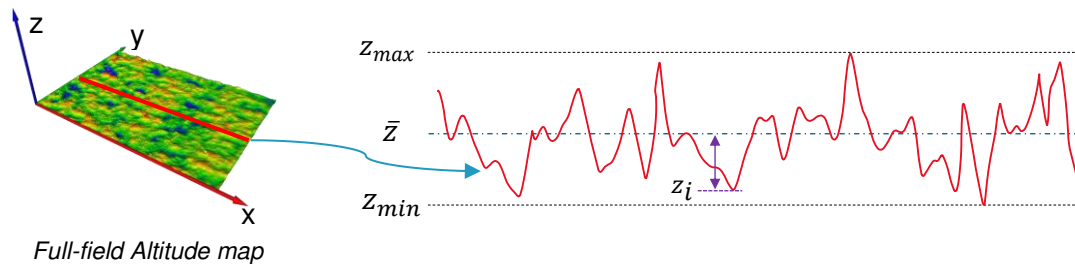

- **Optical-Ra (O-Ra)** is calculated using the altitude map of the measured area. O-Ra is similar than Ra but due to difference in the measurement process it is then called O-Ra to make the distinction. It represents the arithmetical mean deviation of the altitude profile, defined as follow:

$$ORa = \frac{1}{n} \sum_{i=1}^n |z_i|$$

- **Optical-Rq (O-Rq)** is calculated using the altitude map of the measured area. O-Rq is similar than Rq but due to difference in the measurement process it is then called O-Rq to make the distinction. It represents the root mean square of the deviation of the altitude profile, defined as follow:

$$ORq = \sqrt{\frac{1}{n} \sum_{i=1}^n z_i^2}$$

- **Waviness** represents movement of the surface texture (non-flat characteristic of the surface) using the slope map and Standard deviation calculation. This effect is



often influenced by the rolling process of the steel/aluminium sheet during manufacture. The present waviness value cannot be compared directly to the one obtained for C-Coat (different scaling). The scale goes from 0 unit (very low texture) to 30 units (very high texture).

- **Quality** value is based onto the Waviness value averaged and scaled from 0 – poor quality - to 100 – high quality.

## TAMS O-Rough algorithm (E-Coat and R-Mat)

For some time TAMS had the capability to measure E-Coat and R-Mat surface with the standard algorithm called EC-RC-TAMS-STD. This was developed and introduced in 2019, and is described just before in this document.

Rhopoint has been listening to the customer need for measuring such surface in a classical roughness analysis point of view. The new O-Rough algorithm has been designed to satisfy this requirement from the automotive paint industry.

This algorithm has been specifically designed to apply band filtering, before computing any roughness characteristics. Based onto ISO-16610 norm, user has got the possibility to apply High pass (keep only high frequency – short waves-), Low pass (keep only low frequency – large waves-) and band pass (keep only a range of wavelength). Two bands can be defined independently, adjusting low limit, high limit, or both in case of band filtering.

After the algorithm has applied filters, 4 characteristics are calculated following ISO-25178 norm. They are Sa, RaX, RaY, Rsm. User should refer to this norm to know more about calculation formulae. TAMS is performing calculation using the whole field of view 27x16mm from the Altitude topographic map. This map is given without filtering, and is also given for the two selected bands.

To Use O-Rough algorithm, user should make sure to have corresponding licence. Contact distributor to know more.

***Remark:*** TAMS has got capability for others analysis method for E-Coat and R-Mat. Rhopoint can provide **custom computation algorithm for special application**. User should contact distributor for more information.

## Accessories

The instrument is supplied as a standard package complete with all accessories required to calibrate and recharge the unit including:

- Rhopoint TAMS
- Rubber instrument aperture cap
- 2 x 3.7V 6800mHh Li-Ion batteries
- Power Supply (9V/2A) for charging
- Calibration plate (including plastic-ref, silver-ref, check tile-ref)
- 16GB SD Card containing
  - Optimap Reader Software
  - User Manual in PDF version
  - Smart Manager data management software
  - Release note in PDF version
- Cleaning cloth
- Quick Start Guide
- Lanyard (onto instrument)
- Protective instrument carry case with foam

### Optional items

- Rechargeable battery pack (2 x 3.7V 6800mHh Li-Ion batteries)
- Battery pack recharging station

# Functional overview

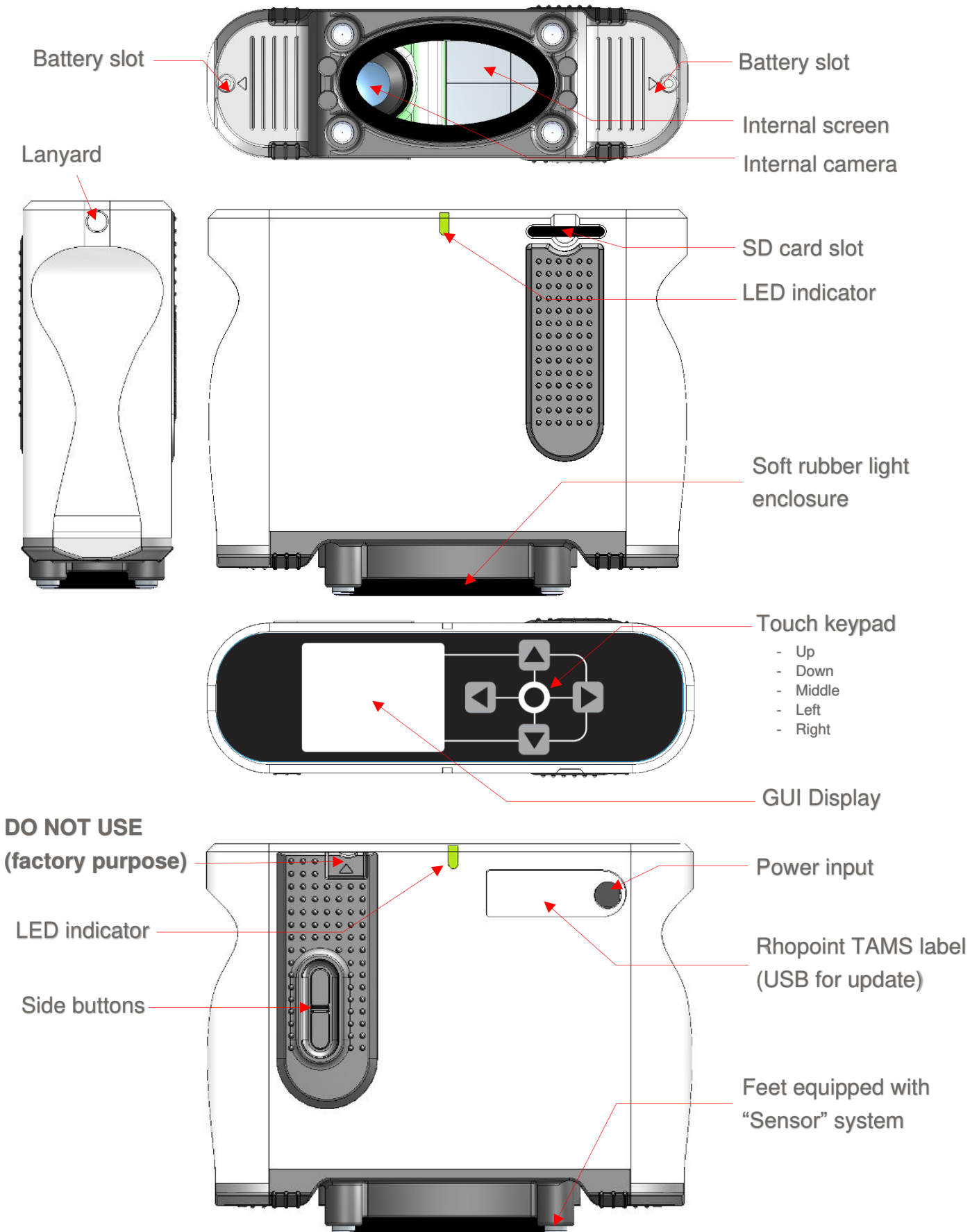

## Power

The Rhopoint TAMS is powered by two removable high capacity lithium ion cells.

Fully charged the instrument will operate continuously for about 5 Hours or >1500 readings.

The mains powered charger supplied will fully charge the instrument in under 5.5 hours (TAMS switched OFF, charging mode only).

**Do not make any measurements whilst the instrument is charging.**

To charge the TAMS connect the output connector of the charger to the power input of the instrument and connect the charger mains input to a suitable mains supply.

**It is recommended to charge the instrument when turned OFF**

When switched off the TAMS will show the following charging screen:

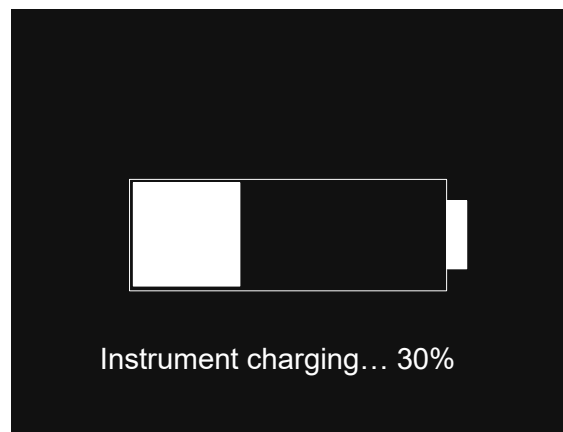

Extra batteries are available as accessories supplied with a charging station allowing remote charging of extra battery sets. This convenient feature allows instant changeover of batteries during periods of high usage.

To remove the batteries, remove the screws from each of the battery compartment lids and slide them away from the instrument as shown in the diagrams that follow. The batteries can then be withdrawn from their compartments and a new fully charged set installed. To ensure correct orientation the batteries can only be fitted into the compartment one-way round.

1

Pull cap out



Remove screw

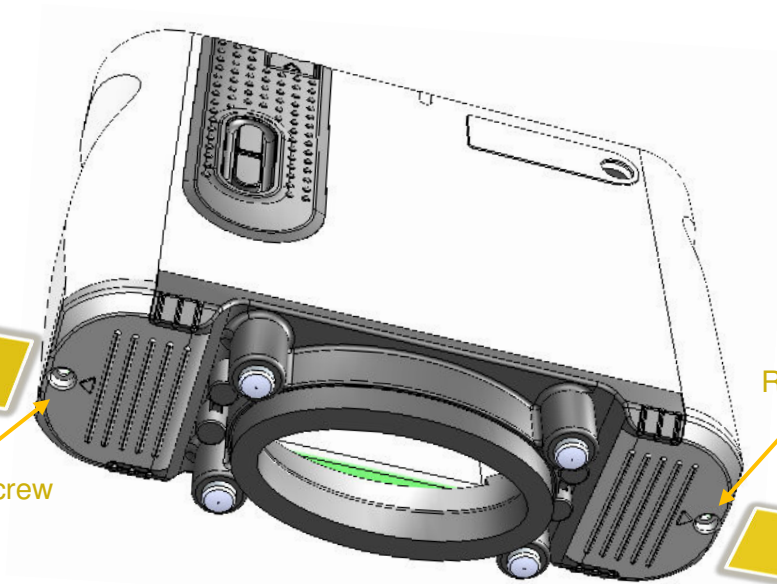

Remove screw



2

Pull cap out

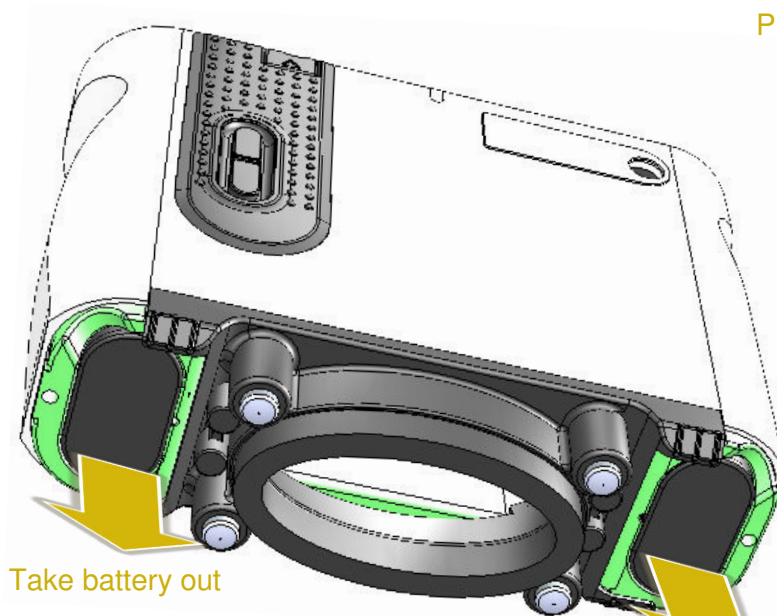

Take battery out

Take battery out

3

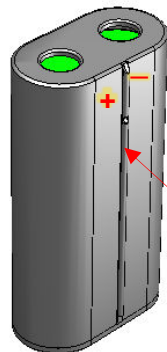

Orientation protected

To switch the unit on, press the lower side button as shown below:

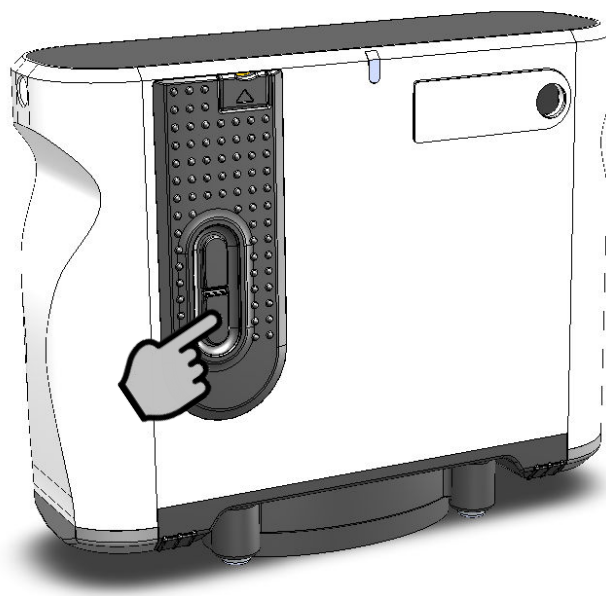

The instrument will display –



And then after approx. 25 seconds the instrument is ready, press any key to continue.



### Sleep mode and beep behaviour:

The TAMS will automatically go OFF if not used for some time. The delay before going OFF can be set in the Menu. See further in this manual the section “Delay before sleep”.

Before the TAMS goes OFF for non-activity reason, it will emit 3 quick beeps. At this point the user has 10 seconds to press any button avoiding the instrument to go OFF. If not, the instrument will finally emit 3 normal beep and go OFF.

### Instrument reset function:

The TAMS has got a reset function in case the unit would be frozen. To reset the TAMS user can press and hold the top side button for 15sec as follow:

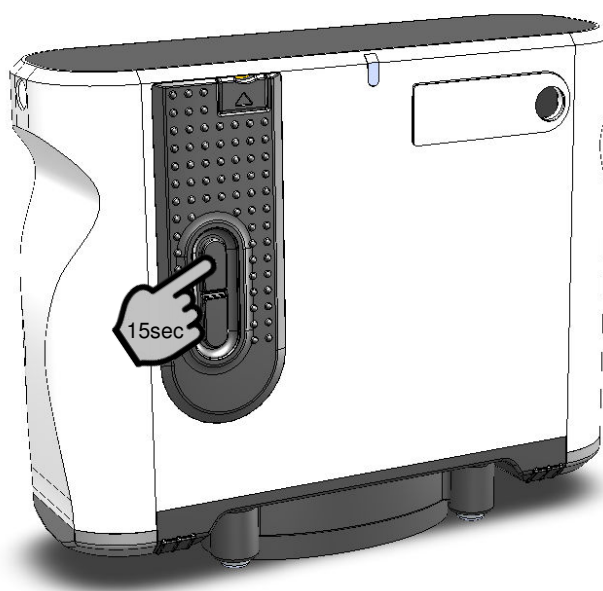

### Battery swap situation:

When the user swap the batteries the TAMS need to estimate battery capacity of new batteries. So in this situation, charger plugged in or not plugged in, the TAMS will start and go straight to MAIN screen in case it is turned ON.

Then a popup message will notify those batteries have been swapped, user must disconnect PSU and wait for 15 sec. Battery capacity will be adjusted in this time.



## Main Screen

With the unit switched ON and initialised the instrument will display the Main screen. Depending on the type surface that was last measured and also the algorithm that was used, layout may vary. In case of C-Coat measurement, using the [CC-STD-TAMS](#) method, Main screen will be displayed as follow:

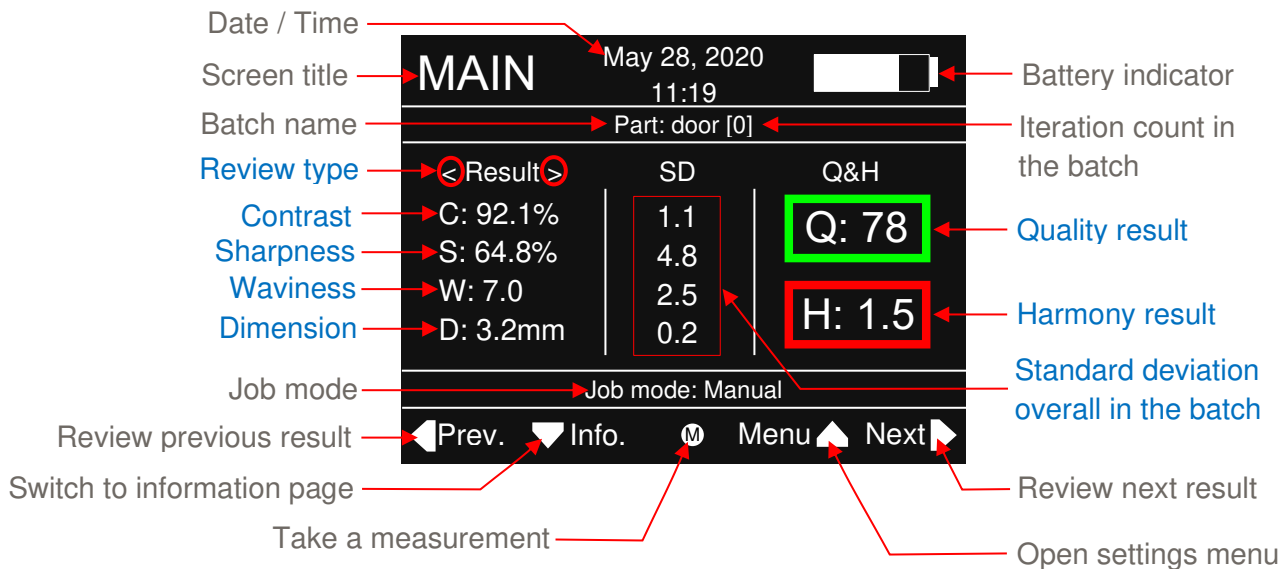

**Batch name and iteration count:** The top information line shows the batch name and the iteration count. This line is always there in the layout and is independent of the chosen algorithm. The iteration count is marked into brackets “[ ]”. Iteration “[0]” indicates that this result is the average for the batch. When user is reviewing results whose count is x, then “[x!]” would indicate that this is the current batch which has not been closed yet. It is still possible to make more measurements for this batch or even delete single result from this batch (or delete the entire batch).

**Review mode:** Measurement can be reviewed by “results”, or by “batch” when pressing ◀ or ▶, this functionality is independent from the algorithm chosen. If the review mode is by “results”, the CC-TAMS-STD algo layout will show “<Result>” on top left, and the user can review every single measurement. If the review mode is by “batch”, the CC-TAMS-STD algo layout will show “<Q&H>” on top right, and the user can review only average results containing Quality and Harmony results. To switch review mode between, press and hold ⏏. The review mode is also indicated in the INFO page. This is useful because some custom algorithm layout may not always indicate the review mode onto the MAIN page (as for CC-TAMS-STD layout), but this will always be visible into the INFO page.

**Value displayed:** The value that are displayed in the middle Main page area depend on the surface measured and the algorithm chosen. Each algorithm will propose its own layout. Above is shown the example in case of C-Coat surface measured with the algorithm CC-TAMS-STD. In this case, Main page shows C, S, W, D results and Q, H only the average result. Also, for this algo, the standard deviation value are displayed.

**Pass/fail indicator:** The user can have a pass/fail visual colour indicator. Green to be pass (inside acceptability range), and red to be failed (outside). This is useful for production usage. easily know if the part measured is inside tolerance looking at the

colour indication. The tolerance criteria can be adjusted in the algorithm menu options. Each algorithm can have its own tolerance criteria. Please refer further in this manual to the corresponding section to know how to apply criteria settings. In the above example, user can set tolerance criteria for CC-TAMS-STD algorithm that will control Q and H value.

Job mode: The Main screen always display the current Job mode, independently of the chosen surface type or algorithm. This will indicate if use is making few measurement on the fly (Job mode OFF), or if user can manually apply a name for the batch (Job mode Manual), or even if user is being guided through a specific job (Guided Job). This is explained further in the section “Measurement using My Car feature”.

Shutter mode: The shutter mode is indicated by an uppercase letter inside the circular middle button drawing. **M** indicate that the shutter mode is **Manual**, so the user can use middle touch key ● or the lower physical button on the side to start a measurement. **A** indicates that the measurement mode is **Automatic** and TAMS is performing measurement continuously by itself (see further in this manual to know how to set and use the automatic mode). When some automatic measurement are ongoing, the middle button turns blue. Then **S** indicates **Sensor** mode, so the user can start a measurement as soon as the bottom feet are in contact with the surface. If the **S** is displayed with a white background, sensor is in standby (selected but not active). Green background indicates that it is now active. Press ● to switch between standby and active.

## Information Screen

By pressing the down key, the user can switch the view to the information page. This page will show information on instrument settings, measurement index in the results and all characteristics that have been set up with the “My car” options. Information page looks as shown below:

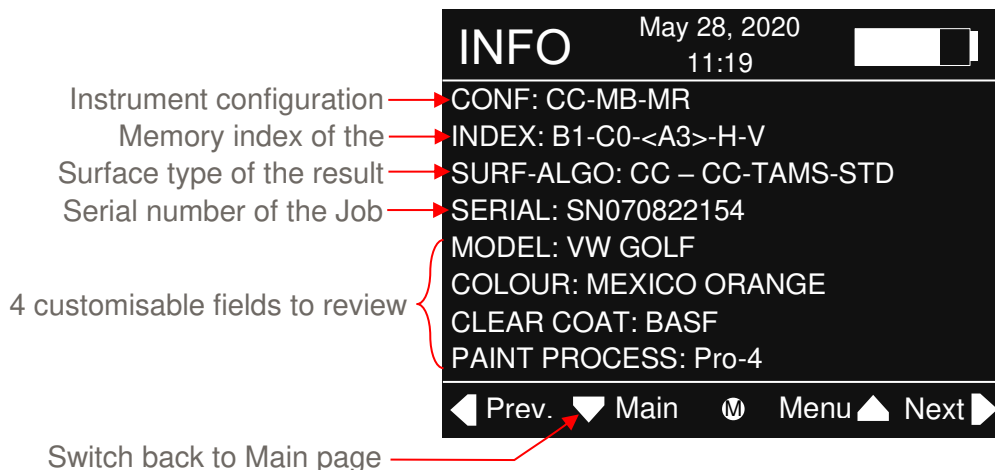

### Configuration logo definition:

- CC: current surface type setting is Clear-Coat
- **EC: current surface type setting is E-Coat**
- **RM: current surface type setting is R-Mat**
- MB: Manual Batch mode selected
- AB(x): Auto batch mode selected with (x) count before auto batching
- MR: Manual appearance Reference has been selected
- AR: Auto appearance reference is selected
- **CI: Save captured image is active**
- **RI: Save result image is active**
- **DA: Save data is active**
- **MA: Save map is active**

■ This feature might require a specific licence key to operate properly. Contact your distributor for more information.

Measurement index: The index line in the example above shows that the current results reviewed is in the Batch 1, this is the count 0 (the last one containing averaged results and Q and H), and this is the absolute result number 3 in memory (Report to section “Results indices and memory organisation” for more information). Also, the first letter “H” indicates that the surface measured was horizontal, and the second letter “V” indicates that the TAMS was vertical for this measurement. Also, the arrows on both side of the A3 indicates that the review mode is currently “by results” (see above concerning the “Review mode”).

Surface and Algo reviewed: The third line indicate that this result is a C-Coat measurement result, operated using the CC-TAMS-STD algorithm. One can note that in fact it is possible at some stage to have the instrument setup for E-Coat measurement (EC logo would appear on top) but the user is reviewing a C-Coat measurement result (CC would appear at beginning on third line), or other.

Serial number: The serial number displayed is the one set up when user started new Job in the “My car” menu. See the “My Car” section to know more about how to set it up.

Customisable fields: Finally, from line 5 to 8, the instrument can display some of the characteristics that have been chosen when editing car characteristics or starting a new car in “My Car” menu. Although up to 15 characteristics can be chosen by user, only 4 of those can be display onto the instrument GUI. The whole set of characteristics will be visible only in the outputted \*.csv result file. Nevertheless, the user can prepare the instrument to choose which field will be visible onto the GUI, please refer to the My Car section to know more about that feature.

# Menu Screen – Organisation and navigation

To access the Menu from the Main Screen press , you reach the first Menu page as follow:

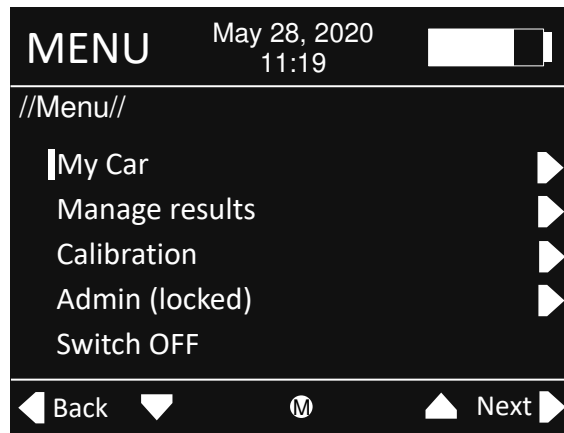

The Menu is organized as shown on the following diagram:

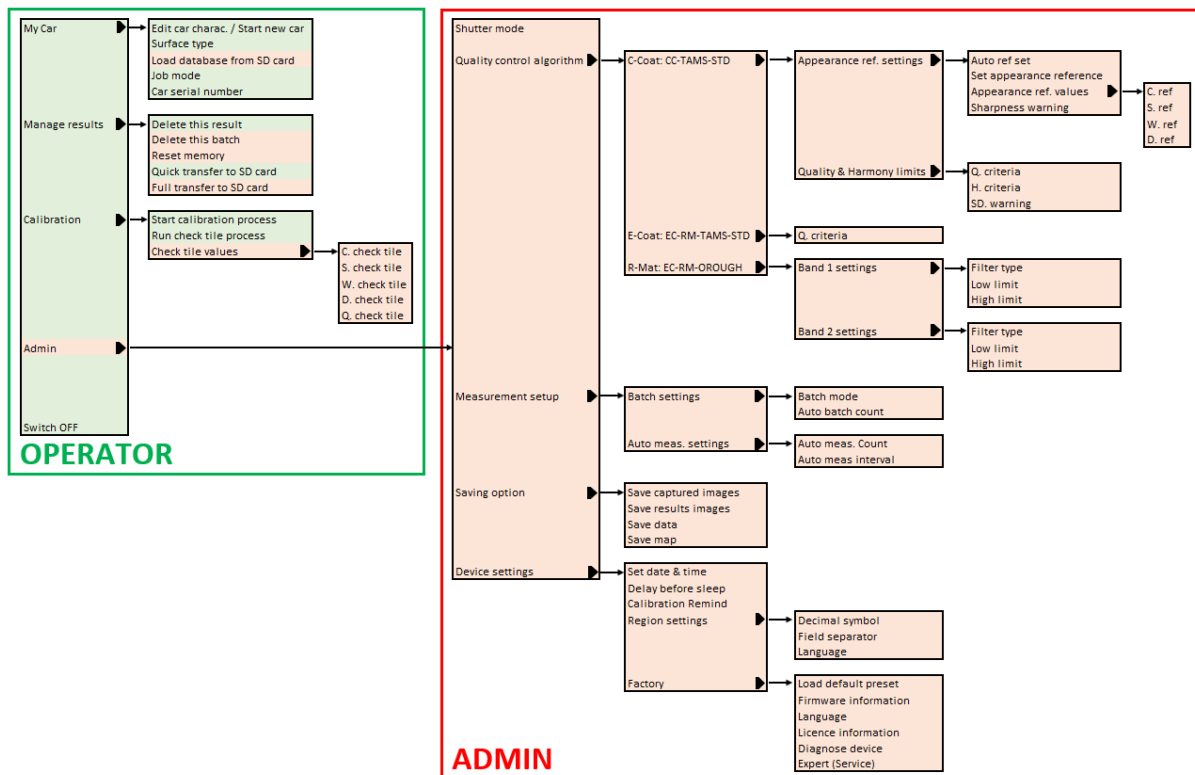

The Menu Screen is split into 2 access levels: OPERATOR, allowing basic options for instrument use and ADMIN allowing access to measurement options and device settings. The OPERATOR level is accessible by anyone. The ADMIN area is protected by an 8-sequence touch combination password. Nevertheless, some features can be located in the operator area but still protected (example: Reset memory), they can only be used if the ADMIN has been unlocked .

## Menu navigation



Press  to go back to the previous menu level.

Press and hold  to jump back directly to Main screen.

Press  to go to select an option or change its value.

Press  or  to move the selection cursor and choose desired option.

Press and hold  to turn the instrument OFF from anywhere in the Menu.

The cursor “I” allows navigation through the option list. If it changes to red “I”, this indicates that the setting mode is enabled, and the corresponding parameter can now be adjusted using  or . Press  again to validate the parameter and exit the setting mode. The cursor turns back to normal “I”.

# Menu Screen – OPERATOR functionality description

## Edit car characteristics / Start a new car

Selecting this option allows the setup of the measurement characteristics of the car using the database in the instrument memory. Make sure you have first uploaded a database inside the instrument.

Press  or  to scroll through the measurement parameters.

Press  or  to select the required option.

Pressing  will validate the characteristics and go to the next one.

The user can still cancel and exit this process by holding down .

A prompt will be displayed to apply (select) the required option and then the next field will be displayed.

## Stop guided process

In case that a user has started measuring a new car using the Guided mode, he can also force to stop the guided process by using this option. In such situation, if the last batch has not been finished, the TAMS will automatically close it.

## Surface type

- **C-Coat:** Select this option to analyse the appearance of a top coated surface finish. The standard algorithm to be used is CC-TAMS-STD, for which Quality and Harmony original TAMS parameters can be obtained. It is recommended to take at least 3 measurements over the surface before batching.
- **E-Coat:** Select this option to analyse E-Coat surfaces. The standard algorithm to be used is EC-RM-TAMS-STD. It is recommended to take at least 3 measurements over the surface before batching.
- **R-Mat:** Select this option to analyse Raw Material surfaces. The standard algorithm to be used is EC-RM-TAMS-STD. It is recommended to take at least 3 measurements over the surface before batching.

## Load database from SD Card

To load a new database into the TAMS from the SD card the instruments memory must first be reset, details on how to do this can be found in the manage results menu which follows. Once reset return to the load database option in My Car and insert the SD card containing the database file (TAMSdatabase.csv) at the root of the SD card. Once the database has been loaded the instrument will display “Loading database completed – press exit to continue”. Measurement may now be made as detailed in the measurement section of this manual.

## Job mode

The job mode can be OFF, Manual or Guided. If OFF, no car characteristics are used, and the TAMS will never ask for any batch name when closing the batch. If Manual, the user must set characteristics at least once at initial stage and can further modify

characteristics at any time. The TAMS will display a prompt message when batching for the user to choose (or not) a name for the batch. The batch name will be picked up from the first column of the database CSV file. If Guided, the user must “Start new car” option and set all characteristics. Part to measure will be displayed at the bottom of the screen in the order they appear in the first column of TAMSdatabase.csv.

### **Car serial number**

The user can set the number of digits to use for the car serial number, from 1 to 15 digits. If the user set for example AB1234, then the serial number will be saved in the results file as SNAB1234.

### **Manage results**

#### **Delete this result**

Allows the deletion of a measurement result in the current Batch. It is not possible to delete a measurement result in a closed Batch.

#### **Delete this batch**

Allows the deletion of a complete Batch whether it is open or closed. User may note that in case of guided mode active, the deleted batch will be proposed for measuring straight after again.

#### **Reset memory**

Allows deletion of all measurement results including results and images. Note this is irreversible and there are no recovery options. Calibration data is not affected however therefore the instrument remains calibrated. Also, this operation do not remove the TAMSdatabase.csv. **This option is only accessible when ADMIN is unlocked.** User may note that in case of guided mode active, this will stop the guided job.

#### **Quick transfer to SD card**

Allows only the global results file and the log file are transferred to the SD card. This transfer mode is much faster than a full transfer. Measurement data are stored in a folder called:

YYYY-MM-DD\_hh-mm-ss\_TAMS#RTSxxxxxxx\_QUICK\_DATA\_TRANSFER

where YYYY-MM-DD and hh-mm-ss refers to the date and time of the transfer action and xxxxxxx refers to the instrument serial number.

Should the transfer need to be cancelled for any reason press ◀.

#### **Full transfer to SD card**

Allows results stored in TAMS to be transferred to the SD card. To export the data, insert the SD card into the TAMS and select this option. Please note that this can take several minutes depending on the amount of data and image content. Should the transfer need to be cancelled for any reason press ◀. When the transfer is finished remove the SD card from the TAMS. Measurement data is stored in a folder called:

YYYY-MM-DD\_hh-mm-ss\_TAMS#RTSxxxxxxx\_FULL\_DATA\_TRANSFER



All results remain in the TAMS memory after transfer. The Reset memory option should be used to free space. **This option is only accessible when ADMIN is unlocked.**

## **Calibration**

Calibration should be performed once a week (preferably at the beginning) by placing the instrument onto the calibration plate provided.

The plate contains 3 reference tiles: plastic-ref, silver-ref, check tile-ref.

Before a new calibration is performed it is recommended to that the instruments memory is reset to ensure that all measurements made after are using to the latest calibration values.

### **Start calibration process**

The calibration process consists of two steps, the user is guided step by step on the screen after having chosen the option Start calibration process. The TAMS will ask the user to place the instrument first onto the plastic ref, and then onto the silver ref.

### **Run check tile process**

To use this function, check tile values must have been set beforehand in the instrument memory. For this the user can refer to the option Check tile values (see further).

The third reference tile check tile-ref is used to verify the calibration has completed successfully, or simply that the instrument is measuring normally. To perform this verification, select Run check tile process and follow instructions on the screen. Basically, this will consist in placing the TAMS onto the black check tile and making 3 successive measurements. The user will be asked to lift the TAMS up and down between each step (to simulate real usage). When the process has terminated, average measured values will be displayed on the screen, and a message will indicate whether the check tile has been verified.

### **Check tile values**

The user can store the C-S-W-D-Q values of the check tile plate into the TAMS memory. This must be done before using the Run check tile process option.

# Menu Screen – ADMIN functionality description



## ADMIN access

The admin area is “unlocked” by default so all parameters are accessible by anyone. To lock it, user can do a long press on Admin. To unlock it back, enter the following key combination from the first menu page: .



When correctly entered the following message will be displayed on the screen: “Admin access is now unlocked” and the Admin option will display: “Admin”.

To re-lock admin access, simply select Admin option and press and hold .

## Shutter mode

- **Manual** - Allows a single measurement to be made by pressing  from the Main screen or the lower side button on the instrument. This will be notified by the letter “M” inside the middle button.
- **Sensor** - Press the instrument onto the surface to make a measurement. To activate / deactivate this function press  from the Main screen. It is recommended that this feature is deactivated when not using the instrument. This will be notified by the letter “S” inside the middle button, with white background in case sensor is deactivated, or green background in case the sensor is activated. In case of measurement error or at the end of a guided job the sensor is automatically deactivated.
- **Auto** – The instrument can be programmed to make several measurements automatically. Number (N) and interval (I) between each measurement can be set in Auto Meas. Settings, please refer to the Menu diagram described above. On the Main screen, simply press  to start automatic reading. It is recommended that this function is only used to make measurements on horizontal flat surfaces. This will be notified by the letter “A” inside the middle button with white background no automatic measurement are running, or blue background in case measurement are running.

## Quality control algorithm

User has got the possibility to choose the algorithm to be used for each surface type. To change the algorithm of one surface type, user should press  successively until the desired algorithm is shown. By default, the algorithm for C-Coat is CC-TAMS-STD, and the one for E-COAT and R-MAT is EC-RM-TAMS-STD. For more algorithm, user should contact distributor. If some settings are existing for the chosen algorithm, user can press . As an example, some settings are existing for CC-TAMS-STD and EC-RM-TAMS-STD, are described here after.

- ✚ For the CC-TAMS-STD, user can adjust different parameters from two sub-categories (Appearance ref. settings and Tolerance settings), described here after.

### **Appearance ref. settings**

#### **Auto ref set**

This option can be switched ON or OFF. If ON, the instrument will automatically make the average results of a batched series as the new appearance reference. This is useful when using the Harmony Value.

#### **Set appearance reference**

After batching a series, use this option to manually set the current results as the new appearance reference used for the Harmony calculation. This option can only be used for C-coat surface.

#### **Appearance ref. values**

The user has the possibility to set manually the reference appearance value for C-S-W-D.

Tip: It is worthwhile to note that with Smart Manager, user now has got the possibility to “re-calculate” any harmony value between any parts by using the car map functionality. Consequently if part have not been measured in the desired order and the instrument is not showing consistent value for Harmony, this can be managed further on Smart Manager.

#### **Sharpness warning**

The Harmony calculation is based on a combination between Waviness and Dimension. Nevertheless, in some situation, the Harmony can be acceptable  $H < 1.0$  but a significant delta-Sharpness exist. In such situation the user has the possibility to receive a Warning, turning this feature ON.

### **Tolerance settings**

#### **Q. criteria**

Set the Quality acceptance limit - red circle (rejected) or green circle (accepted).

#### **H. criteria**

Set the Harmony acceptance limit - red circle (rejected) or green circle (accepted). It is highly recommended to keep the value at 1.0 as it is theoretically the harmony acceptance limit.

#### **SD. Warning**

The user can be notified in case the standard deviation of measurement from the same batch is high. The standard deviation is calculated in live for any new results inside a batch. To get notification, user should turn this feature ON.

- ✚ For the EC-RM-TAMS-STD, user can adjust the quality criteria tolerance, with same behaviour that explained above for CC-TAMS-STD.

- ✚ For the EC-RM-OROUGH, user can adjust the characteristics of the two bands filtering option, as described here after.

### **Band 1 settings**

#### **Filter type**

User can choose the desired filter type for the first band between High Pass Filter (HPF), Low Pass Filter (LPF) or Band Pass Filter (BPF). See in the introduction to know more about O-Rough algorithm.

#### **Low limit**

This is where user can set the cut off value of the first band in case of HPF or LPF selected. In case of BPF, this value is actually the low cut-off limit of the first band. This value is given in millimeters with a resolution of 0.1mm.

#### **High limit**

User can set the high cut-off limit of the first band in case of BPF. This value is not used in case of HPF and LPF. This value is given in millimeters with a resolution of 0.1mm.

### **Band 2 settings**

#### **Filter type**

User can choose the desired filter type for the second band between High Pass Filter (HPF), Low Pass Filter (LPF) or Band Pass Filter (BPF). See in the introduction to know more about O-Rough algorithm.

#### **Low limit**

This is where user can set the cut off value of the second band in case of HPF or LPF selected. In case of BPF, this value is actually the low cut-off limit of the first band. This value is given in millimeters with a resolution of 0.1mm.

#### **High limit**

User can set the high cut-off limit of the second band in case of BPF. This value is not used in case of HPF and LPF. This value is given in millimeters with a resolution of 0.1mm.

## **Measurement setup**

### **Batch settings**

#### **Batch mode**

Choose to batch manually or automatically after a set number of measurements are made within the **Auto batch count** option.

This option can be set to Manual or Auto. When set to Manual batching is performed manually from the Main screen by pressing and holding  until an acknowledge tone

is heard. In case Auto batch is selected, user can still press and hold  to force the batch but will be warned with a message.

### **Auto batch count**

Set the number of measurements to make before the system automatically batches.

## **Auto meas. Settings**

### **Auto meas. count**

When using “Automatic” measurement mode this option allows the number of measurements to be set.

### **Auto meas. interval**

When using “Automatic” measurement mode this option allows the interval between each measurement to be set. This value is set in seconds with a minimum time of 1 sec.

## **Saving option**

### **Save captured images**

Allows the storage of measurement images and data. Saving all measurement images significantly increases the stored data size in the TAMS memory and reduces the amount of measurements that can be stored, also the measurement time increases by several seconds, transfer time to the SD card is also increased. **This feature requires a licence key, contact your distributor for more information.**

### **Save results images**

Allows the storage of results images such as graphs or combined fringe patterns. When set to ON it has the same effects on available storage memory as per the previous option. **This feature requires a licence key, contact your distributor for more information.**

### **Save data**





Allows to save some raw data in txt file format like data used to generate OTF and spectra graphs. **This feature requires a licence key, contact your distributor for more information.**

### **Save map**

Allows to save the altitude map data. Map obtained will be Altitude, SlopeX, SlopeY, CurvatureX, CurvatureY, or even more depending on any custom algorithm used. The output format is \*.res, it is explained further down in this document how this binary format can be read. **This feature requires a licence key, contact your distributor for more information.**

## **Device settings**

### **Set Date & Time**

Set the instruments date and the time using this function. Set values using  and  and move the cursor using  and . To save the new settings select OK and press Enter. To Exit without saving select Exit and press Enter.

### **Delay before sleep**

To save battery power TAMS incorporates a sleep mode. This option allows the setting of the time before TAMS goes to sleep. 10 seconds before it is about to sleep it emits 3 rapid beeps. To prevent the instrument from entering sleep press any key during this time. When 3 slow beeps are heard TAMS goes off. This option can be turned OFF.

### **Calibration Remind**

The frequency of calibration can be set using this option. It is recommended to perform calibration once a week. The user can set a calibration reminder with a value from 1 to 31 days. This option can be turned OFF.

## **Region settings**

### **Decimal symbol**

The user can choose the decimal symbol that will be used in the exported measurement results csv file. This can be dot (.) or coma (,). Warning: if the user must choose the field separator in such way that this will not interfere with the decimal symbol.

### **Field separator**

The user can choose the field separator format of the exported measurement results file in such way that it can be compatible with the region of the computer used. This can be comma (,) or semicolon (;).

### **Language**

The user can choose the language of the instrument. Currently 5 languages are supported: English, German, French, Spanish, Polish. It is possible that after instrument update, the language goes back to English and user need to set again his preferred language.

## **Factory**

### **Load default pre-set**

This option can be used to restore all default parameters in the instrument including language (English default).

## **Firmware information**

Display the firmware version using this option. It is recommended to check the firmware version after performing a firmware update.

## **Licence information**

Display all the licence available in the device. Also indicates validity (red indicates not valid), the validity period and the number maximum of usage.

## **Expert (Service)**

This option is only accessible by the manufacturer for diagnostics.

## **Switch OFF**

Switch the instrument off. It is also possible to switch off by pressing and holding  from anywhere in the Menu.

# Calibration and Verification

## Calibration process

Before measuring with TAMS, you must calibrate the instrument. The calibration procedure will adjust focus camera position and get results of the reference surface (a top coated glass silver mirror).

To calibrate the TAMS, you need the calibration plate provided with the instruments in the box. This plate contains 3 tiles:

- Plastic ref.: used for focus surface settings
- Silver ref: use for focus screen settings and reference measurement
- Tile ref: use to verify the measurement consistency after calibration process. **Do not use during calibration!**

To start the calibration, go to **Menu > Calibration > Start Calibration process**. The TAMS will promptly inform that calibration process will start (but real process will start a bit later), just select YES and press OK.

### Calibration step 1:

The TAMS will first ask to place the instrument onto the plastic ref tile, this is the first one on top of the calibration plate. Make sure that the instrument is sitting properly on the 4 feet, select continue and press OK (at that time, the process is now running). The system is performing surface auto-focus setting.

### Calibration step 2:

Then the TAMS will ask to place the TAMS onto the Silver ref tile. This is the tile in the middle, it looks like a perfect silver mirror. Make sure that the instrument is sitting properly on the 4 feet, select continue and press OK. The system is performing screen auto-focus setting and measurement calibration.

## Verification – Check tile procedure

The user can now verify that the TAMS is measuring properly. For this, you first need to make sure that Tile ref value (bottom black tile) have been set into the instrument. Go to **Menu > Calibration > Check tile values**, and make sure all values correspond to those written on the calibration plate (concerning C, S, W, D, Q). Warning: for accessing Check tile values you must unlock the Admin mode (Please refer to section “Menu screen – ADMIN mode”).

When ready to start the check tile process, go to **Menu > Calibration > Run check tile process**. The TAMS will ask you to place the TAMS onto the black check tile, this is the last one at the bottom of the plate. It looks like a black wavy unclear surface. Place the TAMS on it, make sure all 4 feet are in contact and instrument is stable. Select continue and press OK.



The TAMS will ask you to lift the instrument up and down to simulate real life usage. Lift it up and down, select continue and press OK.

Repeat the operation one more time.

At the end, the instrument will let you know if values have been successfully verified after the 3 measurements performed. Each value has got following tolerance:

C:  $\pm 1.5$  ; S:  $\pm 1.5$  ; W:  $\pm 1.5$  ; D:  $\pm 0.5$  ; Q:  $\pm 3$

# Basic Measurement

## Taking a measurement:

TAMS has been designed for ease of use, whether it be used in single measurement, manual batching mode or single measurement, automatic batching and batch selection mode.

However, for best practice use of TAMS a few important points should be observed –

- Always select a flat surface (or as flat as possible) to make a measurement on
- Always use two hands to operate TAMS, this provides greater stability during measurement optimising accuracy and repeatability of results.
- Use the button on the side of the instrument to activate a measurement.
- Never overextend to make a measurement on a roof surface for instance as the TAMS will not be located correctly producing unreliable results.
- Results for concave and convex surfaces outside the specification (400mm radius) could be potentially unreliable so better to avoid.
- Always ensure at least 3 feet are always in contact with the surface during the measurement.
- With sensor mode enabled the inbuilt sensors in the feet optimise measurement positioning.
- Always keep the TAMS as still as possible during measurement and do not remove from the surface until the green light is showing.
- Remove the instrument from the surface as soon as possible between measurements to avoid unnecessary fatigue.
- This will allow the TAMS to be easily repositioned in time for the next measurement.
- ONLY stay still during image grabbing i.e. when red LED is displayed as it will become uncomfortable.
- Always hold the TAMS at the sides and NOT on top of the glass during a measurement as the touch sensitive keys on top can stop or disturb the process.

Ensure the TAMS has been recently calibrated to the standard provided as detailed in the Calibration section.

## Basic configuration:

If Manual is selected in Batch Mode, each set of results must be manually batched each time by pressing and holding . If selected to Auto this will automatically be performed after the last measurement has been taken as set in Auto Batch Count.

Ensure that the desired surface type has been selected in Menu >> My Car >> Surface type. And also the desired algorithm in Menu >> Admin >> Quality Control Algorithm.

TAMS is now ready to make measurements.

At any time, the user can quickly check the instrument configuration looking at the first line (CONF) in the Info. Screen. To switch between Main screen and Info screen, simply press .

## **Usage:**

As best practice, user should select a near-flat, clean and defect-free area on the surface and place TAMS onto it ensuring the feet of the measurement base (at least 3) are properly in contact with the surface.

Hold the TAMS with two hands and press the side button on the instrument to make a measurement keeping it perfectly still during image grabbing whilst the LEDs are red. The instrument should be removed when the LEDs turn green to avoid unnecessary fatigue during measurements. Each measurement takes about 8 seconds, 4 seconds for the image grabbing and 4 seconds for the results calculation.

**Do not move the instrument before the screen and LEDs turn green.**

## **Results:**

In C-Coat mode and using CC-TAMS-STD algorithm, 4 sub-characteristics C., S., W., and D. are displayed for each measurement. At least 3 measurements are recommended to be made over the surface then the batch closed manually by pressing and holding  or automatically if selected to obtain the average and Quality (Q) results. A message is then displayed asking whether the measurement point for the batch needs updating, this reference and saves the batched results to the measurement point name as defined in column 1 of the My Car database.

Using CC-TAMS-STD for C-Coat surface, user can decide to use those results as new “appearance reference”, ensuring that further Harmony value will be calculated referring to this reference. To do so, user should go to the setting of the CC-TAMS-STD algorithm as described above (Menu >> Admin >> Quality control algorithm >> C-COAT: CC-TAMS-STD >> App. Ref settings >> Set appearance reference).

Using EC-RM-TAMS-STD for E-Coat or R-Mat surface, 3 sub-characteristics O-Ra, O-Rq and W will be displayed for each measurement. At least 3 measurements must be taken before the batch is closed. Once the batch is closed average results and the Quality (Q) value are displayed.

## Measurement using My car feature

The My Car option allows easy configuration of TAMS for each automotive characteristic and exterior body part list. It also allows to set manually or automatically the batch name (part name), with the possibility of guidance for the user.

The job mode must be set properly. With Job mode OFF, the “My car” options are simply not used, and the user can do measurement as he wants to without pay attention to characteristics. The two other options are Job mode Manual and Job mode Guided as shown below:

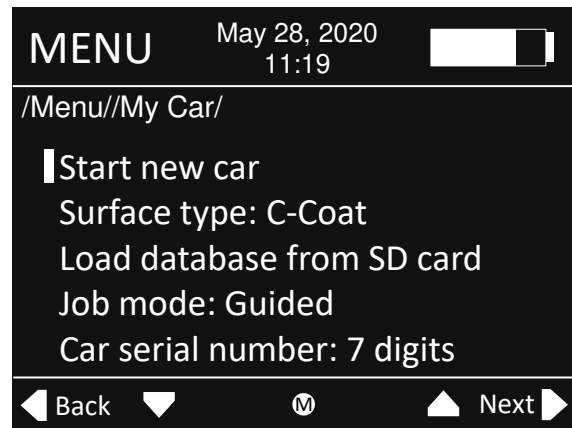
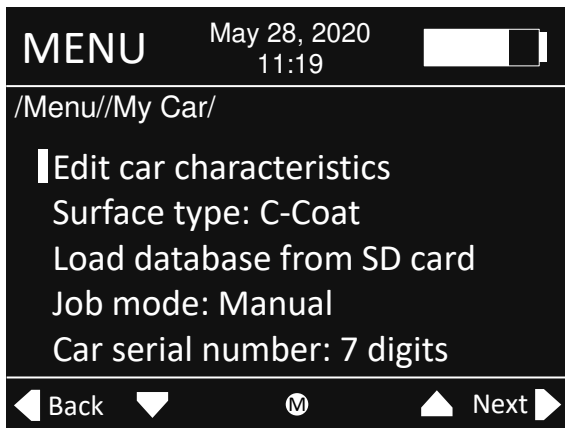

### Job mode: Manual

When Job mode Manual is selected, the user can set car characteristics using the option “Edit car characteristics”. This option is described below. In the Main screen, the bottom line will show “Manual job”. The user can do some measurement as he wants to, and when batching (batch can still be manual or automatic), the system will ask the user to give a name to the batch. The user still has the possibility refusing to give any name to the batch (the system will automatically apply the name “not set”). In case the user wants to give a name, a choice name window will appear, and the user can pick one up using ▲ and ▼ and validate using ●. If while choosing a name, the user finally does not want to give a name anymore, he has the possibility to press and hold down ◀ to cancel the name process. All part name possibilities come directly from the very first column of the TAMSdatabase.csv file.

### Job mode: Guided

When Job mode Guided is selected, the user will have the possibility to be “guided” by the instrument on which part to measure while measuring a whole car. After having chosen guided mode, or after having finished to measure a car in this mode, the user must Start a new car. At this point the user can set all car characteristics, in the same way than with Manual mode. This option is described below. After having set characteristics, the system will jump automatically to the Main screen, and will show in the bottom the part to measure, as shown below:

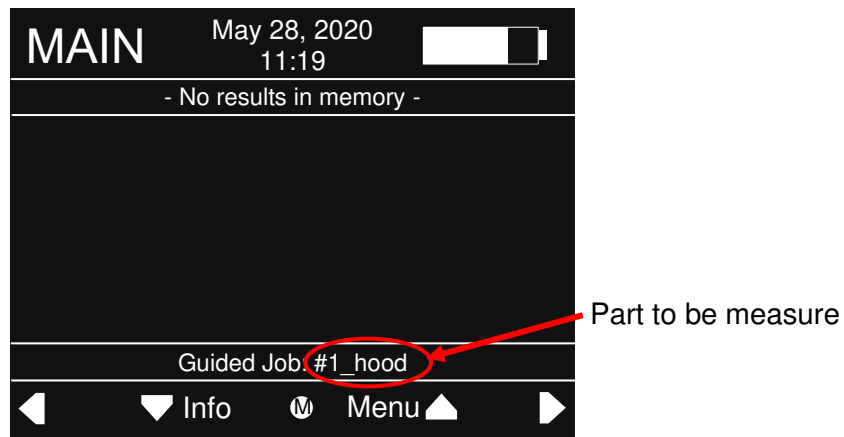

In this mode it is recommended to use the auto batch option, and the sensor measurement mode in such way that the user does not need to press any key, just measure and follow instructions.

Swap or ignore a part

Nevertheless, the user has the possibility to “Swap” or “Ignore” a part, only if the part to be measure has not been started yet. To do so, the user can Press and hold ● to option those two options. A prompt message box will appears asking for choosing “Swap” or “Ignore”. Choosing Swap will postpone the part for later and the system will propose the next part in the list. Choosing Ignore will simply cancel this part and it will not be measured. Or, to cancel this action, the user can press and hold ◀ and continue.

During the whole guided process, the system will pick up part to measure in the list of the first column of the database csv file. When all parts have been picked up and measure by the user, the system will display “Finished” on the bottom of the screen as follow:

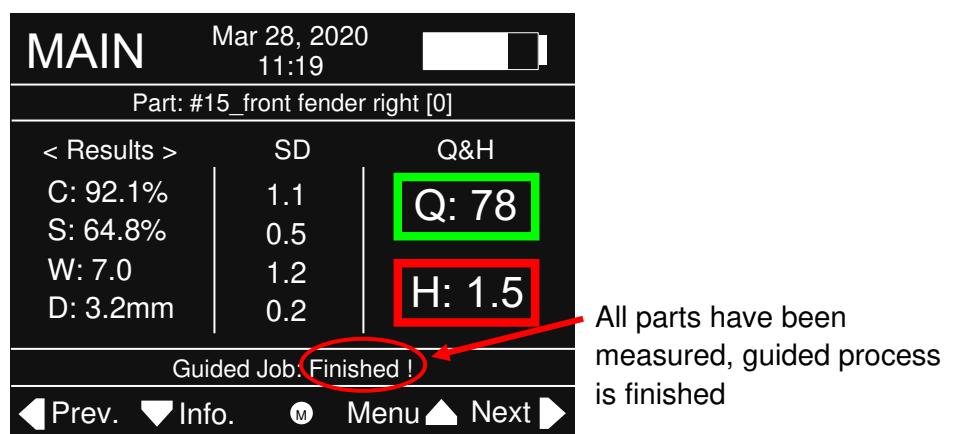











To start again a guided process and measure a new car, the user must Start a new car again and go through the all characteristics setting again.

At any time, the user can also stop the guided process. Just go to Menu > My car and select “Stop guided process”.

## Edit car characteristics / Start new car

With a measurement database loaded into the TAMS as detailed in the My Car section, configure the instrument to the characteristics required for the vehicle being measured. To use the My car option, select Manual or even Guided in the Job mode. Then select Edit car characteristics (Manual) or Start a new car (Guided) and press .

The system will first ask for the serial number. Simply use  and  to move the cursor to the desired position. Then use  and  to change the digit value. The digit range is 0 – 9 and A – Z only.

Press  to apply and go to the next field characteristic setting. For each field, use  and  to select an item and then press  to apply and go to the next field. User can also jump backward and forward between fields using  and .

Configure the TAMS to the required batch settings using the Batch Settings option in the Admin menu.

# How to setup My Car

## Basic feature description

The My Car feature allows easy configuration of TAMS for each automotive characteristic and exterior body part list. A database can be compiled in Excel - or also using the Smart Manager application - containing such global characteristics required and installed into the TAMS memory for instant recall using the SD card supplied.

<i>Displayed as part name on Main screen</i>	<i>Displayed on Info screen (4 fields only)</i>				<i>Used for car settings but not visible for review on TAMS</i>	
Part name	MODEL	Colour	Process	Environment	Clear coat	Repair
Hood	GOLF	Blue	p2018	Lab.	BASF	none
Door	PASSAT	Grey	p2017	Prod. Line	Hemmelrath	Stage-1
Roof	TOURAN	White	P1987	Exterior	PPG	Stage-2
Fender right	UP	Red		Audit room		
Fender left		Black				
Trunk						
Up to 60 characters		Up to 99 items			Up to 15 fields in total	

Sample TAMS configuration file in Excel

Part name, Model, Colour, Process, Environment, Clear Coat and Repair are among many parameters that can be defined by the user in the TAMS, allowing flexible operation and process recording. A maximum of 15 fields (columns) can be created in the CSV file on excel. The first field **must contain the list of part name that will be given to a batch and displayed on Main screen**, as this specific category will be used by the instrument to give a name to a batch. Each field can store up to 100 items maximum (vertically, including field title). The maximum width of each field is 60 characters. **The CSV file can be saved using comma separator or semicolon separator** (depending on your computer's region settings) and TAMS will automatically detect the used separator. The database CSV file must always be **saved as with the exact name TAMSdatabase.csv** for file detection reasons by the instrument.

As explained in the Information screen section above, the user can choose 4 fields that will be displayed on the Information screen. To make a field visible, it needs to be in a column from 2 to 5 of the database CSV file. In the example above, the user will be able to review directly on the instrument the following fields: Model, Colour, Process and Environment.

## Extended feature description

TAMS has now the capability to measure parts following different sequence, instead of following only one list of part sequence -which is given by the first part list data field in the TAMSdatabase.csv. In fact, one can imagine cars with 2 doors or car with 4

doors, or even car with or without spoiler etc. Therefore, it can be useful for the user, when selecting all my car parameter (colours, paint line etc..), to select a sequence (S1, S2 etc..). When used in job mode Guided (or even Manual), the TAMS will propose part to be measured from a specific sequence list.

To enable this function, the user should create in the TAMSdatabase.csv file a field **named exactly SEQUENCE**, as follow:

Part name	MODEL	Colour	Process	SEQUENCE	Clear coat	Repair
Hood	GOLF	Blue	p2018	none	BASF	none
Door	PASSAT	Grey	p2017	S1	Hemmelrath	Stage-1
Roof	TOURAN	White	P1987	S2	PPG	Stage-2
Fender right	UP	Red		S3		
Fender left		Black		S4		
Trunk						

There is no restriction concerning the position of this field, except that it cannot be in first position.

Then the user should **create a second file called TAMSsequence.csv**, which will contain different sequence (list of part), whose name must correspond to items given above in SEQUENCE field, as follow:

S1	S2	S3	S4		
Hood	Door front	Roof middle	hood		
Door	Door rear	Roof left	fender		
Roof	Spoiler	Roof right	roof		
Fender right	boot	Roof front	boot		
Fender left		Roof back			
Trunk					

The file TAMSsequence.csv has exactly same limitation than the original database one, and no restriction concerning the first column.

Upload: Same procedure to upload TAMSdatabase.csv and TAMSsequence.csv.

Usage: When user is starting a new car (in Guided or Manual job), and selecting a sequence (S1, S2 etc.), the system will try to read the sequence list. If the file is found and the selected list are found, the guided job (or even in manual mode) will follow the desired part list. If the file is not found, or if the desired list is not found into the file, the part name list used will be the original one contained in first column of the TAMSdatabase.csv file.

Tip: It is a good idea to keep an item called “none” (or similar) in the SEQUENCE field of TAMSdatabase.csv that is NOT existing in the TAMSsequence.csv file so that the user has the possibility not to use the sequence feature he desired, but instead the original list in the first column of TAMSdatabase.csv.



## Results indices and memory organisation

Every single measurement made by the user is saved into the instrument, in several global result file called TAMS\_CC\_TAMS\_STD.csv (for the standard C-Coat algorithm) and TAMS\_EC\_RM\_GM\_STD.csv (for the standard E-Coat and R-Mat algorithm). Some more file can exit in case different algorithms have been used.

While using the TAMS, the user has the possibility to give name to batch, and set car characteristics as well, for better post-analysis. Nevertheless, the TAMS is using a continuous incrementation of the results, by distinguishing the Batch, Count and Absolute index. By the way, one can note that for every single result reviewed on the instrument, those index values are visible on the INFO page, on the second line called INDEX. Please refer to the Main screen section for more information.

It is then important to well understand how this organisation takes place into the instrument memory. Let's look at the following example:

Batch index	Count index	Absolute index	User Operation	Instrument Operation
BATCH#1	COUNT#1	ABS#1	Take a reading	Measurement & computation
	COUNT#2	ABS#2	Take a reading	Measurement & computation
	COUNT#3	ABS#3	Take a reading	Measurement & computation
	COUNT#4	ABS#4	Take a reading	Measurement & computation
	COUNT#0	ABS#5	<b>Manual or Automatic Batch closing</b>	<b>Average/Quality/Harmony computation</b>
BATCH#2	COUNT#1	ABS#6	Take a reading	Measurement & computation
	COUNT#2	ABS#7	Take a reading	Measurement & computation
	COUNT#0	ABS#8	<b>Manual or Automatic Batch closing</b>	<b>Average/Quality/Harmony computation</b>
BATCH#3	COUNT#1	ABS#9	Take a reading	Measurement & computation
	COUNT#2	ABS#10	Take a reading	Measurement & computation
	COUNT#3	ABS#11	Take a reading	Measurement & computation
	COUNT#0	ABS#12	<b>Manual or Automatic Batch closing</b>	<b>Average/Quality/Harmony computation</b>
BATCH#4	COUNT#1	ABS#13	Take a reading	Measurement & computation
	COUNT#2	ABS#14	Take a reading	Measurement & computation
	COUNT#3	ABS#15	Take a reading	Measurement & computation
	COUNT#4	ABS#16	Take a reading	Measurement & computation
	COUNT#5	ABS#17	Take a reading	Measurement & computation
	COUNT#6	ABS#18	Take a reading	Measurement & computation
	COUNT#7	ABS#19	Take a reading	Measurement & computation
	COUNT#8	ABS#20	Take a reading	Measurement & computation
	COUNT#0	ABS#21	<b>Manual or Automatic Batch closing</b>	<b>Average/Quality/Harmony computation</b>
BATCH#5	COUNT#1	ABS#22	Take a reading	Measurement & computation
	COUNT#2	ABS#23	Take a reading	Measurement & computation
	COUNT#3	ABS#24	Take a reading	Measurement & computation
	COUNT#4	ABS#25	Take a reading	Measurement & computation

This example is telling us that the user has done 4 measurements for the first batch. Then, he decided to close the batch (or eventually the instrument was set to close the batch automatically after 4 measurements) and at that point the instrument has calculated the result of this batch, which has the COUNT#0. This result - even if it was not taken by the user directly - constitute a result in the memory and has an absolute index assigned, as any other result, which is ABS#5 in the example above.





Then one can note that any result having the COUNT#0 is the final one calculated by the TAMS (after batch closing operation) and containing all averaged results but also the Quality & Harmony values.





Then we can see that for the BATCH#2, the user took 2 measurements, and 3 measurements for the BATCH#3, 8 measurements for the BATCH#4. We can also see

that the BATCH#5 has not been closed yet, and so far, 4 measurements have been taken for this batch.

With the example above, it is also interesting to see what the two Review mode possibilities are (see before, Main screen description section). In fact, when the review mode is set "by result", the user can review for example ABS#1 >> ABS#2 >> ABS#3 >> ABS#4 >> ABS#5 >> ABS#6 >> ABS#7 >> ABS#8 >> ABS#9 and so on (this is represented by red curved arrow in the example above). User can go backward and forward indeed. In the other hand, if the review mode is set "By Q&H", then the user will review only the final result COUNT#0 of the batch and will go for example from ABS#5 >> ABS#8 >> ABS#12 >> ABS#21 (this is represented by green curved arrow in the example). This last review mode is more convenient for reviewing a lot of batch result after having measured a complete car or example, as you do not necessarily see every single result.

## Long press command reminder

The TAMS has got a touch control system on top next to the screen. This contains 5 different keys which are     and . Each of them can have two different action whether it is simply pressed or long pressed. The long press command can be used for different keys and in many different situations, here after is a summary.

- Long press on 
  - From Main screen: Allow to manually close the batch, or to force closing batch in case auto batch is selected.
- Long press on 
  - From Main screen: Allow to swap the “Review mode” between “by results” and “by Q&H”
- Long press on 
  - From Main screen: Allow the user to access quickly to a previous result or batch depending on review mode selected
  - From the Part name window: Allow the user to cancel the choice process after batching in Manual job mode. The default name “not set” will be affected to the part.
  - From the car “Start new car” window: Allow the user to exit the car characteristics process before reaching the end. Warning: in Manual or Guided mode, this will avoid start measuring a new car, as the user must go through the whole car characteristics process to start measuring a car.
  - From the transfer to SD card window: force to stop and exit the transfer process. User should use this function only if the classic cancel copy operation (short press on left) takes long time.
  - From anywhere in the Menu: allow to jump back directly to the Main screen
- Long press on 
  - From the Main screen: Allow the user to access quickly to the next results or batch depending on review mode selected
  - From the anywhere in the Menu screen: Allow the user to turn OFF the instrument
- Long press on 
  - From the Main screen in Guided job: give the user the possibility to swap or ignore a part. This will launch the choice window.
  - From the Menu: By selecting Admin and this will lock this area and all related features.
  - From the Menu: By selecting Expert(service) and this will lock this feature.

## Transfer results on SD card

The TAMS is capable in transferring results onto the SD card. Please note SD card must be formatted in FAT32 32kb for compatibility, and size must be  $\leq$  32GB. In this way user can analyse results on a PC and do some data post analysis. To operate a transfer to the SD card user should go to **Menu >> Manage results >> Quick/Full transfer to SD card**. There are two types of transfer: **Quick** and **Full**.

### Quick transfer to SD card

User can use this option to get the project file compatible with Smart manager (\*.prj), one global results file for each individual algorithm that has been used (\*.csv) and the log.zip file transferred to the SD card. Also, the Licence\_info.txt, TAMSdatabase.csv and TAMSsequence.csv files are copied. This transfer mode is quicker than a full transfer because no images are copied. On the SD card, a main export folder will be created whose name is:

YYYY-MM-DD\_hh-mm-ss\_TAMS#RTSxxxxxxx\_QUICK\_DATA\_TRANSFER

where YYYY-MM-DD and hh-mm-ss refers to the date and time of the transfer action and xxxxxxxx refers to the instrument serial number.

Should the transfer need to be cancelled for any reason press . After export, data can be used on a computer especially using the Smart Manager software to read the \*.prj file.

### Full transfer to SD card

Using this option, the user will get the same output than with quick export, plus the full folder structure with BATCH and COUNT that may contain some images in case user has saved some images, or some data. Images will be \*.bmp files type, and data will be \*.txt type. Also, will be exported results of calibration, autofocus and check tile verification with full data. On the SD card, a main export folder will be created whose name is:

YYYY-MM-DD\_hh-mm-ss\_TAMS#RTSxxxxxxx\_FULL\_DATA\_TRANSFER

To understand the folder structure, user should refer to the section **Results indices and memory organisation**.

User may need to open the \*.csv results file for each algorithm that has been used. All \*.csv outputted files has got the same starting structure, and same ending structure. Only the middle structure part differs in regard to the parameters that have been calculated.

### First part of the CSV structure result file:

- TAMS\_serial\_Number

This is the serial number of the instruments used for those measurements

- date\_time

This is the date and the time at the beginning of the measurement

- Surface\_type

This is the surface for this measurement. This can be C-Coat, E-Coat or R-Mat.

- Algo\_type

This is the algorithm used for this measurement. Default is CC-TAMS-STD for C-Coat and EC-RM-TAMS-STD for E-Coat and R-Mat.

- Batch

This is the Batch index. For more information user should refer to the section **Results indices and memory organisation**.

- Count

This is the measurement index inside the current batch. For more information user should refer to the section **Results indices and memory organisation**.

- Abs

This is the absolute measurement index. For more information user should refer to the section **Results indices and memory organisation**.

#### **Last part of the CSV structure result file:**

- SD\_warning

This contain Y for Yes or N for NO to indicate if high Standard Deviation has been detected during this batch. This could indicate that one or several measurements have not been done correctly.

- TAMS\_orientation

This record the orientation the device for this measurement. User may note that in case of horizontal surface, TAMS\_orientation will always be horizontal. In case of vertical surface, TAMS\_orientation can be horizontal e.g. the top screen is landscape or vertical e.g. the top screen is portrait.

- Surface\_orientation

This record the surface orientation for this measurement.

- UCID

This is the Unique Car ID. This parameter is renewed at each new car measured, or when the Job mode is changed, or when the surface type is changed. Essentially, this allow user to distinguish two car measurements especially if the same car has been measured twice.

- Car\_serial\_number

This is the car serial number that has been set up. If no serial number has been set, then value will be **not set**.

- Any field further

Any field after Serial number are the field that have been uploaded using the TAMSDatabase.csv file. Maximum is 15 fields.

### **Middle part of the CSV structure result file for CC-TAMS-STD:**

- Contrast

This is the contrast result.

- Sharpness

This is the Sharpness result.

- SharpnessQ

This is the adjusted sharpness using contrast correction which is used for Quality calculation.

- Waviness

This is the waviness value for C-Coat.

- Dimension

In C-Coat measurement, this contain the dimension value (dominant structure size).

- Quality

This is the Quality results.

- Harmony

This is the Harmony results for C-Coat. Harmony value is calculated using results of the current measurement and results of the reference one. See **Appearance ref. settings** section in the admin menu description to get more information on how to use properly the appearance reference.

- App\_ref\_Contrast

This is the appearance reference contrast value in the memory when Harmony has been calculated. Contrast is not used for H calculation, but user may find useful to keep full appearance characteristics of his reference surface.

- App\_ref\_Sharpness

This is the appearance reference Sharpness value in the memory when Harmony has been calculated. Sharpness is not used for H calculation, but user may find useful to keep full appearance characteristics of his reference surface.

- App\_ref\_SharpnessQ

This is the appearance reference SharpnessQ value in the memory when Harmony has been calculated. This value is not accessible in the Menu. SharpnessQ is not used for H calculation, but user may find useful to keep full appearance characteristics of his reference surface.

- App\_ref\_Waviness

This is the appearance reference Waviness value in the memory when Harmony has been calculated. This waviness value has been used to calculate the current value of Harmony.

- App\_ref\_Dimension

This is the appearance reference Dimension value in the memory when Harmony has been calculated. This Dimension value has been used to calculate the current value of Harmony.

- SD\_C

This contain the Standard Deviation of the contrast since the beginning of the current batch.

- SD\_S

This contain the Standard Deviation of the sharpness since the beginning of the current batch.

- SD\_Sq

This contain the Standard Deviation of the sharpnessQ since the beginning of the current batch.

- SD\_W

This contain the Standard Deviation of the waviness since the beginning of the current batch.

- SD\_D

This contain the Standard Deviation of the dimension since the beginning of the current batch. Value will be 0 if the current measurement is not an average result.

#### **Middle part of the CSV structure result file for EC-RM-TAMS-STD:**

- ORa

This is the Optical Ra result.

- ORq

This is the Optical Rq result.

- W

This is the Waviness result. This Waviness result **cannot** be compared to the Waviness result from CC-TAMS-STD.

- Quality

This is the Quality result. This Quality result **cannot** be compared to the Quality result from CC-TAMS-STD.

## Middle part of the CSV structure result file for EC-RM-OROUGH:

- Band#1\_filter\_type

This is the type of the first band.

- Band#1\_low\_lim

This is the low limit of the band 1. Single cut-off value in case of HPF or LPF.

- Band#1\_high\_lim

This is the high limit of the band 1. Not used (0) in case of HPF or LPF.

- Band#1\_Sa

This is the Sa result for the first band.

- Band#1\_RaX

This is the RaX result for the first band.

- Band#1\_RaY

This is the RaY result for the first band.

- Band#1\_RsM

This is the RsM result for the first band.

- Band#2\_filter\_type

This is the type of the second band.

- Band#2\_low\_lim

This is the low limit of the band 2. Single cut-off value in case of HPF or LPF.

- Band#2\_high\_lim

This is the high limit of the band 2. Not used (0) in case of HPF or LPF.

- Band#2\_Sa

This is the Sa result for the second band.

- Band#2\_RaX

This is the RaX result for the second band.

- Band#2\_RaY

This is the RaY result for the second band.

- Band#2\_RsM

This is the RsM result for the second band.

**Warning: This algorithm required special licence key to be used**



## How to read \*.res file format on PC

The TAMS can create altitude, slope and curvature map, if the user has got licence keys for this feature. See above to know how to activate such saving option.

To get files exported on SD card, user must perform a “full transfer to the SD card”. Then, user will find Altitude.res, SlopeX.res, SlopeY.res, CurvatureX.res, CurvatureY.res.

The \*.res file format contains first a header made of 256 bytes (from byte index 0 to byte index 255). To know more about header format user can contact his distributor. Then starting at byte index 256 are the data written “in line”. Data are recorder in double precision 64bits. The map size is 743 x 480 pixels. Consequently, one file \*.res will have a size of exactly  $743 \times 480 \times 64 + 256 \times 8 = 22,827,008$  bits, so 2,853,376 bytes (this can be verified in file property).

Using any kind of 3D mapping software such as Matlab, Voxler, Surfer or others, user can easily create 3D rendering of the surface topography. Would the user experience some difficulties to read the \*.res file, we recommend to contact the distributor.

# Troubleshooting

## **I do not see my results on the Main screen**

Make sure the you are on MAIN screen. You can switch the Main screen view from Main (MAIN) to Information (INFO) by pressing .

## **I cannot give a name to my batch when batching**

Make sure that Job Mode is configured on Manual. Also make sure that you have loaded the database in the TAMS. Please refer to My Car section to know more about database creation and upload.

## **I cannot start a new car in Guided job**

Make sure that you have selected guided job.

## **I cannot load database from SD card**

Make sure that you have unlocked the ADMIN mode. Also, make sure that the memory has been reset. Then make sure to respect the specification to create database csv file. Please refer to My Car section.

## **I cannot delete a result**

Only results that belong to open batch can be deleted.

## **I cannot reset the memory**

Make sure that you have unlocked the ADMIN mode.

## **I cannot make a Full transfer to SD card**

Make sure that you have unlocked the ADMIN mode.

## **I cannot access the Admin mode**

Go to the first Menu level and press the following key sequence –



When correctly entered the following message will be displayed on the screen: “Admin access is now unlocked”, the Menu option Admin will display: “Admin”.

## **I want to lock the Admin mode**

Go to the first Menu level, select Admin, and press and hold  Admin mode is now locked. The Menu option Admin will display: “Admin (locked)”.

## **I cannot change the surface type**

The current batch must be closed before changing the Surface type.

## **I cannot change the algorithm**

The current batch must be closed before changing the Algorithm.

## **I cannot turn ON the auto ref set option**

This function can only be used for C-Coat surface.

### **I cannot use the function set as appearance reference**

This function can only be used for C-Coat surface.

### **I cannot access the Expert (Service) option**

Expert area is not accessible. This function requires a password to access.

### **In sensor mode, the measurement does not start when the instrument is placed onto the surface**

Ensure sensor mode has been activated. The sensor can be activated and deactivated on the main screen by pressing ●. When the sensor is activated, the middle button turns green, and when deactivated it goes back white. Ensure this feature is deactivated after use and before storage.

### **The instrument says surface not compatible**

Ensure the correct surface type has been selected in My car settings. Then ensure you are measuring a surface corresponding to the selected one.

### **The instrument says light enclosure problem**

Ensure the instrument was properly in contact with the surface during measurement. Also verify the integrity of the soft rubber enclosure system near the measurement aperture.

### **The instrument says that high STD has been detected**

The TAMS has detected that one or several measurements have not been made properly into the batch, resulting in a large standard deviation value for one or several parameters calculated. The instrument was not properly placed onto the surface, or the user moved during the measurement. It is advised to delete the batch and repeat measurements again. STD limit are hardcoded into the device and are equal to 5 unit for each characteristic.

### **The dot representing the middle button on the screen has turned red**

The TAMS is in error state and should be rebooted. If this problem persists, contact distributor.

### **I cannot change the decimal symbol**

Memory must be empty before changing the decimal symbol. Also, make sure that the decimal symbol would not conflict with the field separator already selected.

### **I cannot change the field separator**



Memory must be empty before changing the field separator. Also, make sure that the field separator would not conflict with the decimal symbol already selected.

### **I cannot start the measurement in Manual or Guided mode**

In Manual or Guided mode, you must Set car characteristics or Start a new car before doing any measurement. For that, go to Menu>My car> Set car characteristics or Start a new car and go through the all car characteristics process.

### **The instrument is stuck somewhere in the measurement process**



If the TAMS go stuck during the measurement process, the user can:

- Try to stop measurement by pressing down 
- If the process takes more than 30 seconds to stop, the user should hold down  for 6 seconds. This will restart the computation engine (takes ~ 25 sec).

### **I cannot open the file log.zip in the exported folder**

The log.zip file is a file that contains only debug information for the service team. The user does not have access to this file and does not need this at any time.

### **My TAMS is stuck in the copy process**

Try to cancel the copy by pressing . If the cancel process still takes a while, press and hold  to exit the transfer. Then when you get back the control on you instrument, turn it off and restart it as an issue may have occurred with your SD card. Nevertheless, as something wrong probably happened during the copy, it is highly advised to check your SD card size and condition, check the battery level and restart the instrument. Make sure that the battery level is enough before trying to proceed to data transfer again.

### **My TAMS gave error message during the measurement**

An error happened during the image grabbing. Press OK and re-try measurement.

### **When I turn ON a saving option, TAMS says “licence error”**

You probably do not have any valid licence for this feature. Verify your TAMS licence state (refer to section “TAMS licence keys”), and /or contact your distributor.

### **My TAMS says “Factory Service and Calibration is needed!”**

Your TAMS needs to have service and calibration in factory. Please contact your distributor to return your TAMS for annual checking. This message will pop-up automatically after 100,000 measurement or after one-year usage.



# TAMS Licence keys

The TAMS has got a licence key control to offer access to extended features. The TAMS has been designed for measuring C-Coat for automotive surface finish and any TAMS has got this feature enabled by default.

Some extended work has offered the possibility to get new computation algorithms. Those are protected by licence keys. To know more, contact distributor.

Also, people working in lab could be interested in getting more RAW data concerning OTF and spectra graph, or even getting altitude map for E-Coat and R-Mat surfaces. Those features are protected by licence keys.

## **How can I know which licence keys are currently in my instrument:**

To know the current “Licence state” of the TAMS, user should go to Menu >> Admin >> Device settings >> Factory >> Licence information. A page will display all valid licence currently installed in the device. User can press  and  for going to next page. User can exit this licence viewer by pressing .

Also, user can make an export to SD card, and open the licence key file call *Licence\_info.txt* that has been generated inside the export folder. Licence keys type are described, but also period range of usage, counter usage, and final validity result. In case the instrument needs to have annual calibration, a special message will be written on top of the file.

## **How to get more licence keys:**

To get more licence key and get more functionality with TAMS, user should contact his distributor.

## **How to install new licence keys:**

A licence key is a 64 digits character string. One licence key enables one feature for one TAMS. To install one (or several) new licence keys into the TAMS, user should create (or get from distributor) a text file called **TAMS\_LICENCE\_KEYS.txt**. File name must be exactly like this. This file can contain one or several licence key one after the other separated by carriage return and new line.

After this file has been created or usually obtained from the distributor – make sure about the file name! – user can copy it onto the SD card. User should insert the SD card and reboot the TAMS. The licence key update will take place automatically at boot up. To confirm licence keys have been accepted and updated, user should make quick export to SD card and read the licence key file generated into the export folder, which describes the current licence state.

# Technical Specification

## Hardware

- Processor: Quad-core Cortex-A72 (ARM v8) 64-bit SoC @ 1.5GHz
- Display: Color IPS screen + 2 indicator LED's on aluminum case sides
- Control: 5 touch keys + 2 physical buttons + Sensor system
- 3 axis accelerometers for instrument orientation recording
- Memory: 32GB internal + SD card slot (up to 32GB, SD card can be only used for data transfer)
- Battery: 2 × 3.7V 6800mAh Li-Ion (removable)
- Battery life: >5h or >1500 measurement
- Weight (including batteries): 1kg
- Size: 172x129x53 (aluminum / glass / plastic)
- Connectivity: SD card / micro USB (for updating only)

## Measurement

- Field of view: 27mm × 16 mm
- Resolution (surface): 37 $\mu$ m/pixel
- Automatic focus and luminosity control
- Acquisition time: <5sec
- Computation time: <5sec
- Data management: export via SD card
- Maximum measurement: 9999 or 20GB of data